

SEL-3350



Rugged, versatile computing platform for utility and industrial applications

- Configurable as a Real-Time Automation Controller (RTAC), a Blueframe® application platform, or an industrial computer running a Microsoft Windows or Linux OS.
- Cost-effective rack- or panel-mount model with an Intel Atom quad-core 1.6 GHz processor, available in 1U and 3U form factors.
- Durable design with a broad operating temperature range from -40° to $+85^{\circ}\text{C}$ (-40° to $+185^{\circ}\text{F}$).
- High-quality single-level cell (SLC) SSDs and error-correcting code (ECC) memory.
- Worldwide ten-year warranty, local technical support, and no-charge diagnostic and repair services.



Hardened Platform, Reliable Performance

Built for reliability, versatility, and security, the SEL-3350 computing platform offers the performance and flexibility you need for your most demanding, rugged applications. Adhering to the same high standards we use in all of our protective relays, the SEL-3350 offers a solid-state design, substation-rated components, no moving parts, and silent operation—all backed by our ten-year, no-questions-asked warranty.

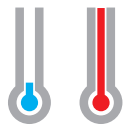

-40°C +85°C
-40°F +185°F



NO MOVING
PARTS



SHOCK/VIBRATION
RESISTANCE



ECC RAM



ESD
RESISTANCE



SLC SSD
MEMORY



CONFORMAL
COATING



Reliable, Available, and Serviceable

Focused on running dedicated embedded applications that require 24/7 availability, the SEL-3350 is designed around RAS—reliability, availability, and serviceability.

Reliability

We design, manufacture, and test every SEL computing platform in the U.S.A. so they can withstand harsh conditions, including temperatures ranging from -40° to $+85^{\circ}\text{C}$ (-40° to $+185^{\circ}\text{F}$), up to 15 kV of electrostatic discharge (ESD), fast transients, high electromagnetic interference, vibration, and shock up to 15 g. All SEL computing platforms conform to or exceed IEC 61850-3, IEEE C37.90, IEEE 1613, and IEC 60255 standards and are backed by a ten-year, worldwide warranty.

Availability

Monitor and alarm for numerous system services and conditions through the included programmable Microsoft Windows Management Infrastructure (MI)/Windows Management Instrumentation (WMI) interface and configurable alarm service, Backup and Recovery Tool (BaRT), and watchdog timer to minimize downtime with automatic recovery from system crashes.

Serviceability

Perform diagnostics, change out SSDs, and install software and an OS. Additionally, SEL System Monitor (SysMon) logs events specific to the installed system to aid in quick recovery.



Product Overview

SEL-3350 1U Model

LED lamp test button

Four programmable bicolor LEDs

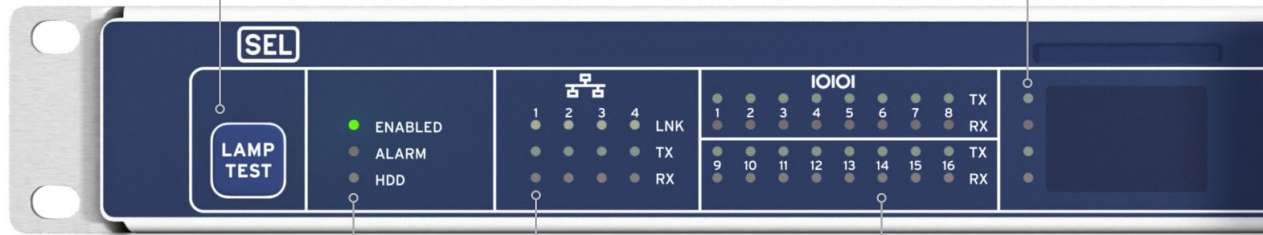

Operational status, alarm, and HDD activity LED indicators

Serial port Transmit and Receive LEDs

Ethernet port link status and network LEDs

DisplayPort monitor connection

16 built-in RJ45 EIA-232/422/485 ports

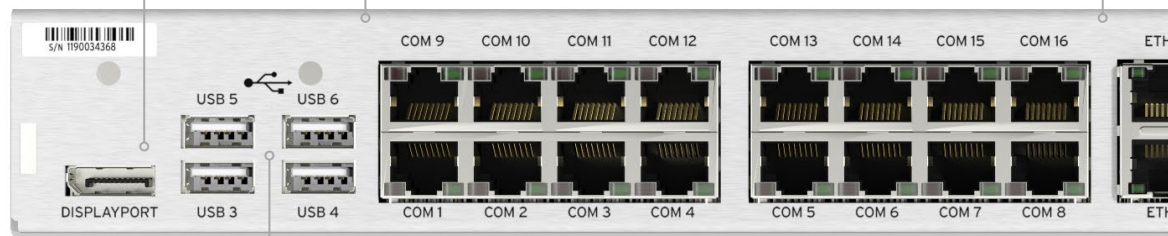

Four USB 2.0 ports

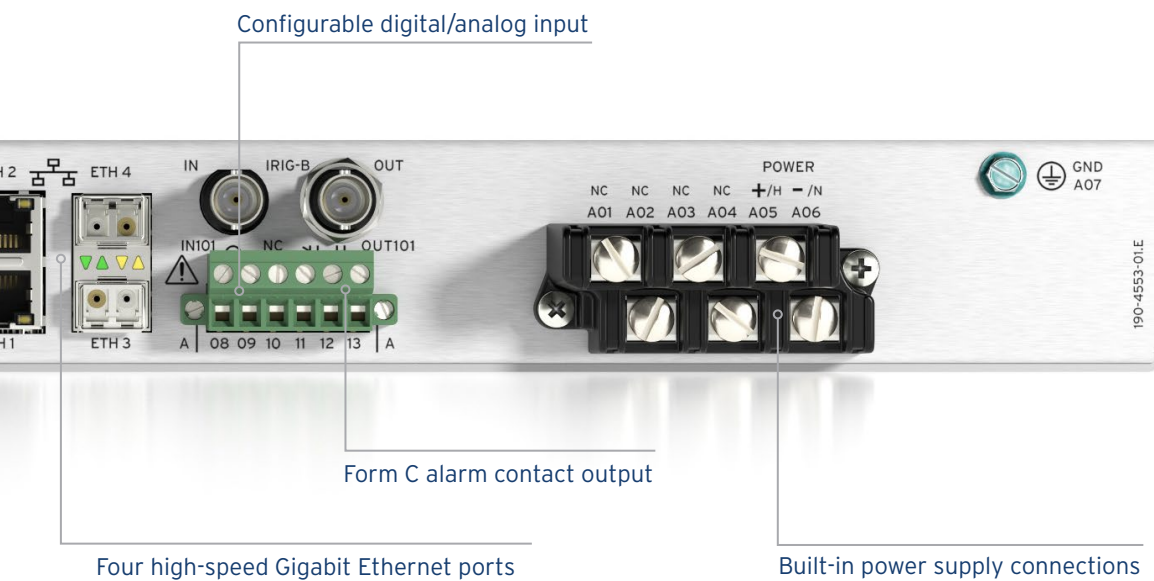
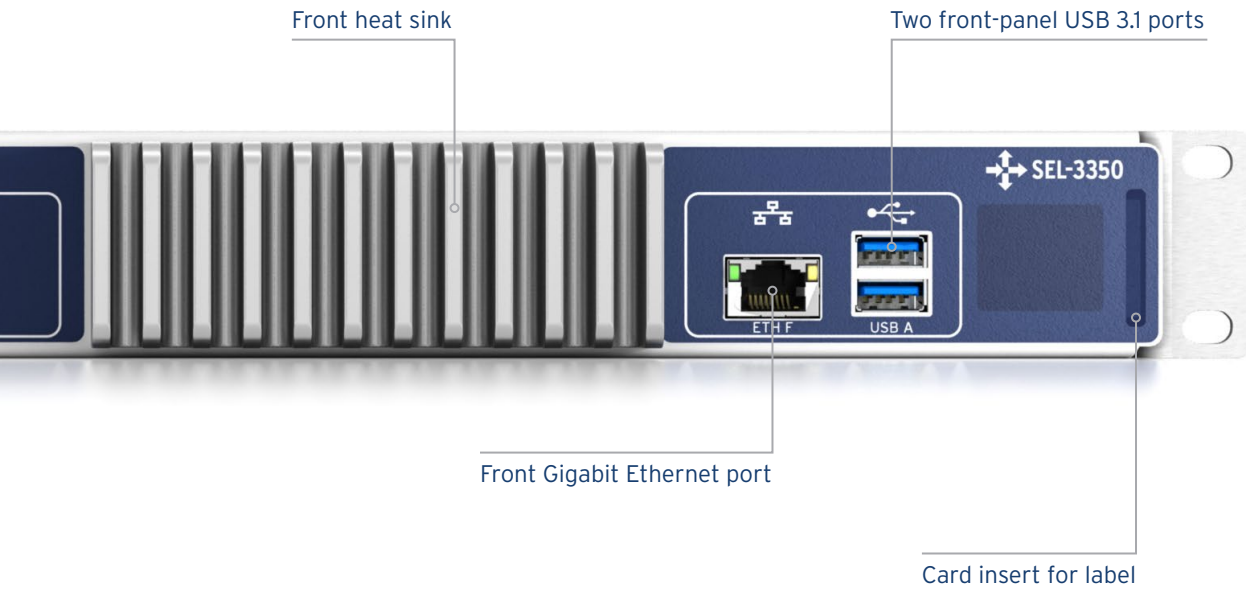

Four high-speed Gigabit Ethernet ports with the following configuration options:

Four RJ45 ports

Two RJ45 and two small form-factor pluggable (SFP) ports

Four SFP ports

SEL-3350 3U Front

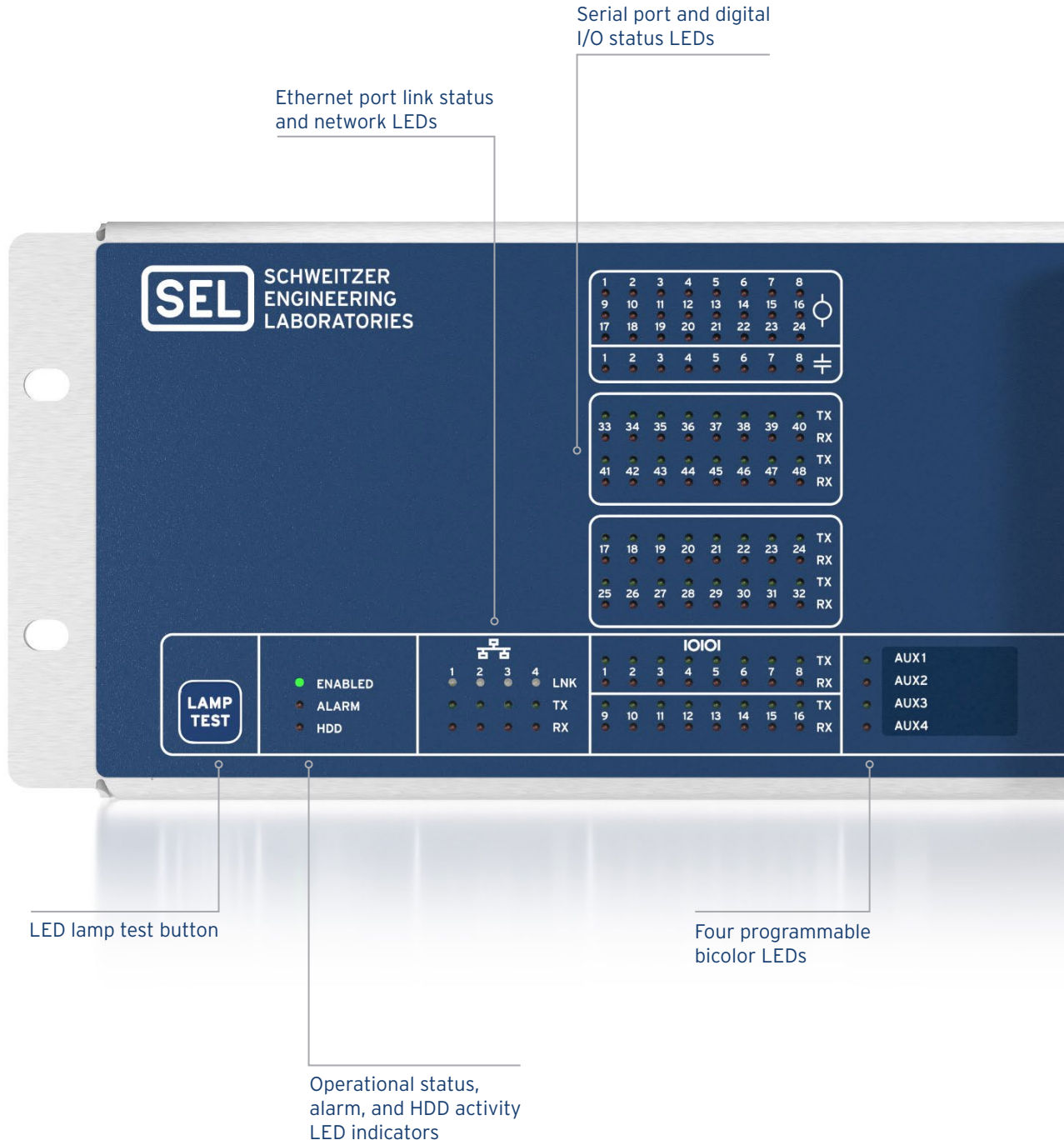



Front heat sink

Card insert for label

SEL-3350

ETH F

USB A

Front Gigabit Ethernet port

Two front-panel USB 3.1 ports

SEL-3350 3U Back

8 Form A digital outputs

Up to 48 RJ45
EIA-232/422/485 ports

DisplayPort monitor
connection

Four USB 2.0 ports

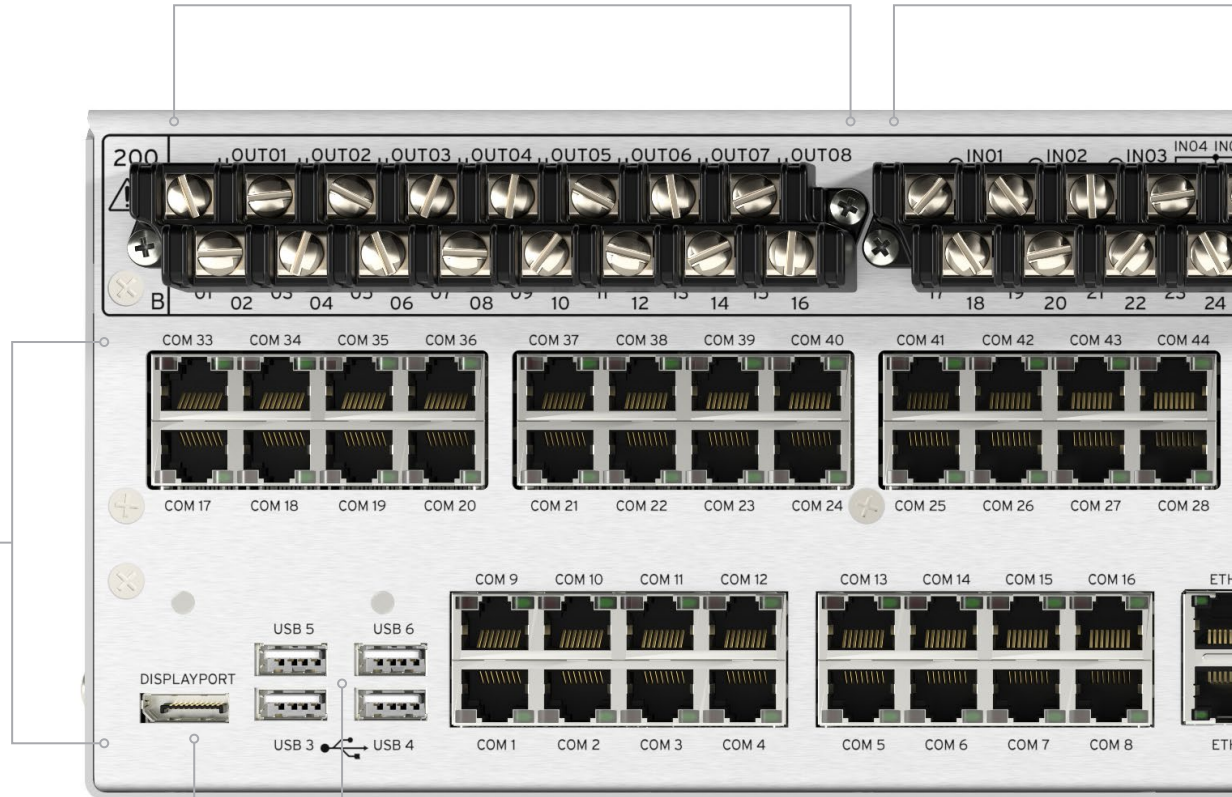

24 software-selectable digital inputs

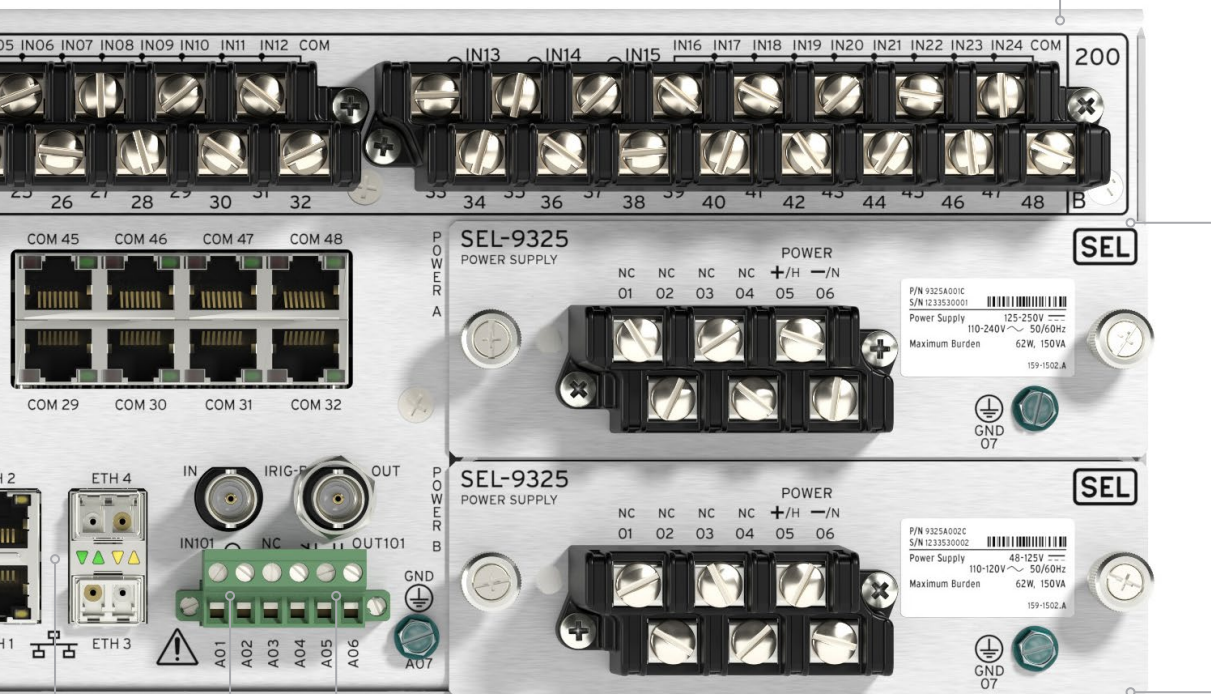

Redundant hot-swappable power supplies

Form C alarm contact output

Configurable digital/analog input

Four high-speed Gigabit Ethernet ports with the following configuration options:

- Four RJ45 ports
- Two RJ45 and two SFP ports
- Four SFP ports

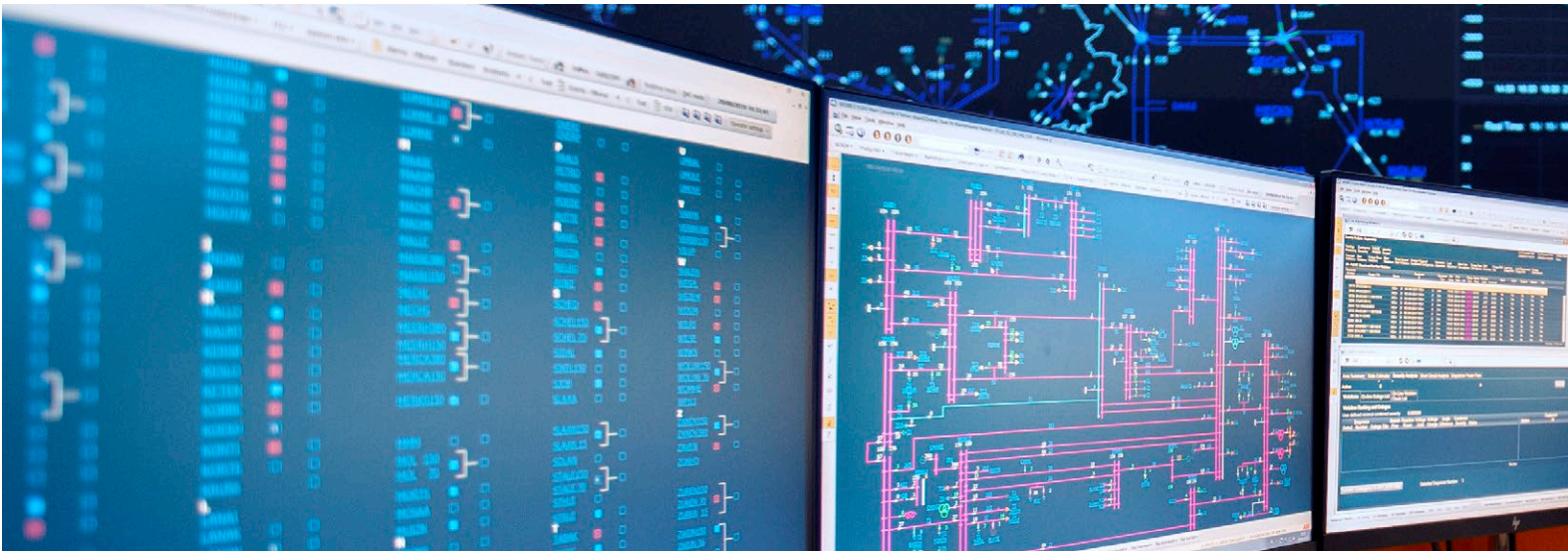

Applications

RTAC

Order the SEL-3350 as an RTAC for secure automation applications, such as a substation HMI or SCADA remote terminal unit (RTU) or for data concentration or event collection.

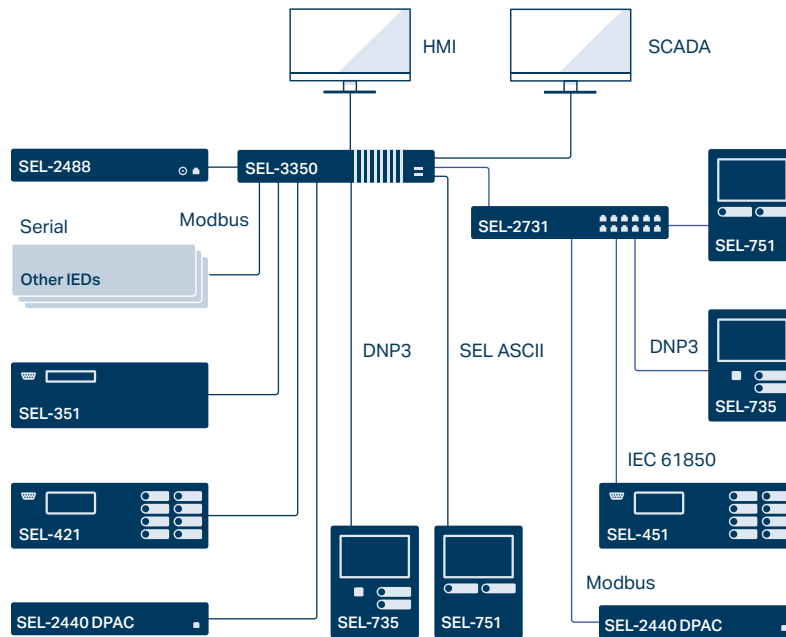

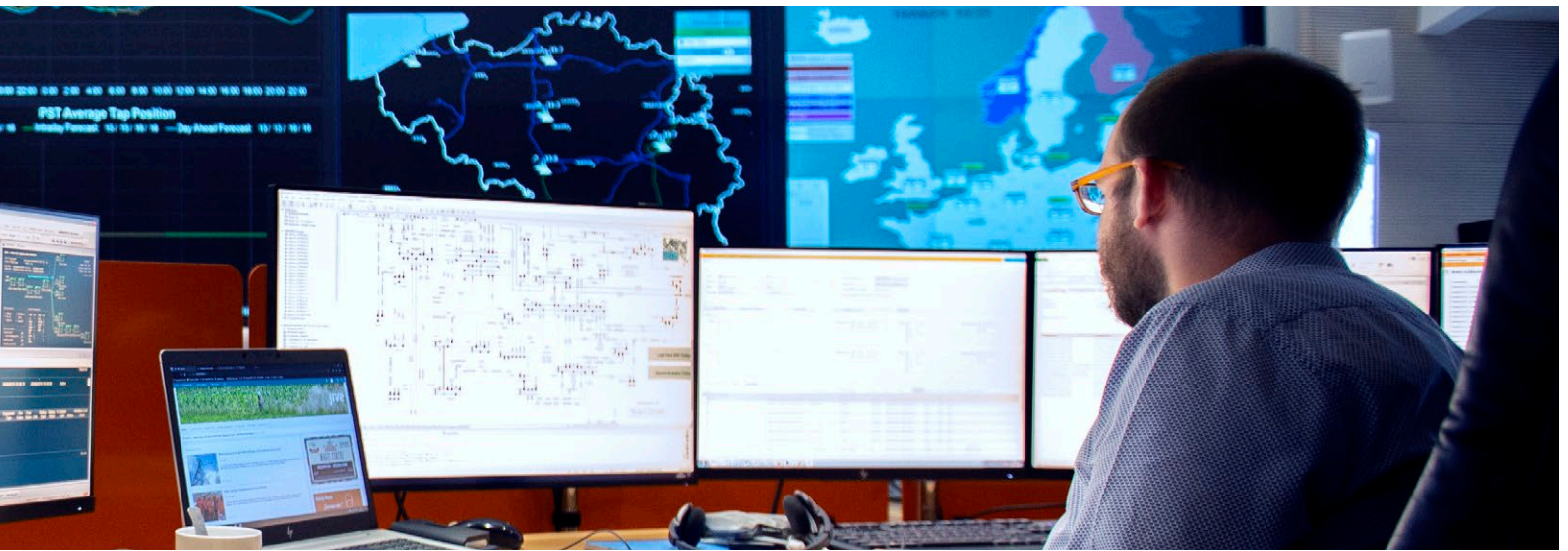

Blueframe

Improve your power system operational technology (OT) network management, simplify security patches, and ensure availability using the SEL Blueframe application platform. You can configure SEL computing platforms (SEL-3350, SEL-3355, and SEL-3360) with Blueframe to run specialized software applications, including the Data Management and Automation (DMA) and Distribution Management System (DMS) suites.

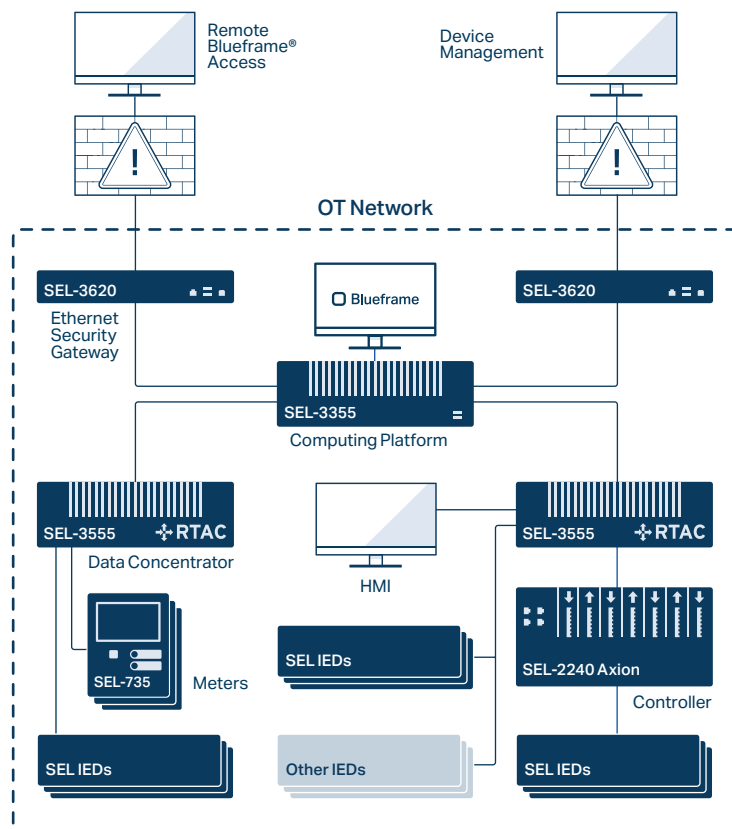

 Blueframe

Information Processor: Data Concentrator/Protocol Converter

Seamlessly and flexibly concentrate data and convert protocols with any SEL computing platform and a wide range of data concentration and protocol conversion software.

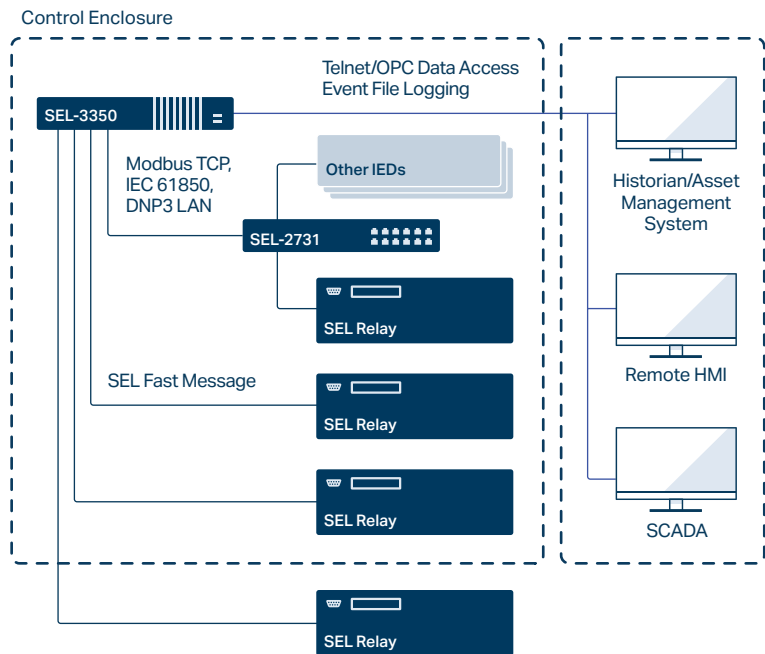

Kiosk

Select the SEL-3350 for remote user applications that require the power of a dedicated high-performance computer. With the option of a small 1U formfactor, the SEL-3350 packs the computing power your application needs into a limited space. Passive cooling and a broad temperature range mean it is possible to install the SEL-3350 in locations where off-the-shelf computers would not survive. With one of the highest mean time between failures (MTBF) ratings in the industry, the SEL-3350 can operate with little or no maintenance, making it ideal for unattended operation.

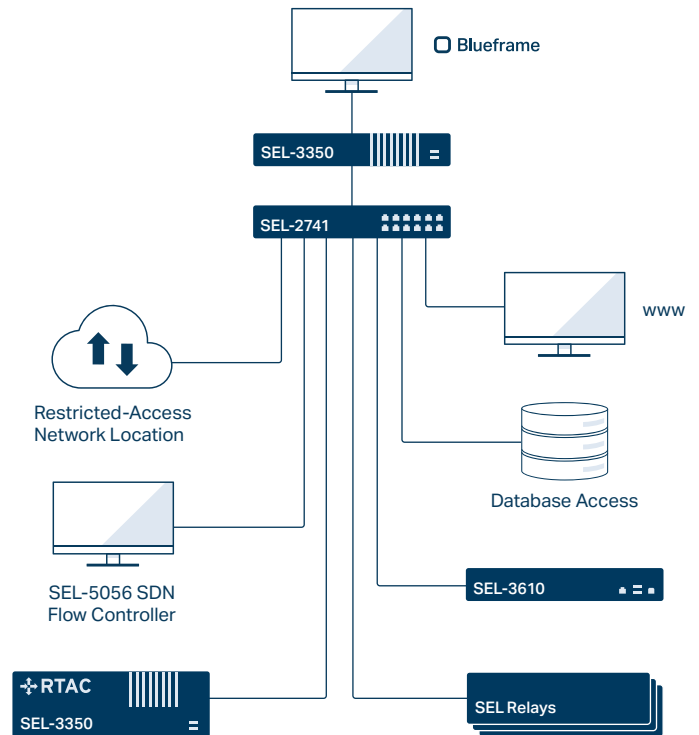

Engineering Workstation

Choose an SEL computing platform as your engineering workstation platform to get a reliable and robust system suitable for the harshest environments. You can view and change IED settings, view report and event data, and easily access diagram drawings and documents onsite. In addition, you can securely and remotely access the engineering workstation using Windows Remote Desktop or Secure Shell (SSH).

HMI Visualization, Monitoring, and Control

Use the SEL-3350 to make a secure system visualization, monitoring, and control point for your substation or plant. You can leverage CIS Security Benchmarks settings to meet NERC CIP and other industry compliance standards.

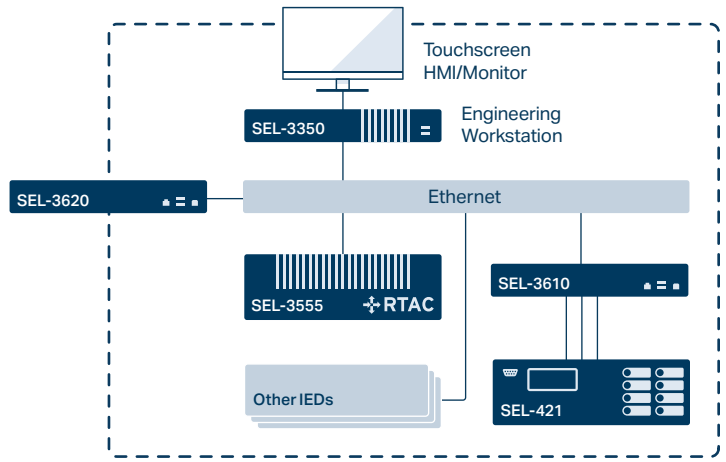

SEL-3350 Specifications

General

Operating Systems	<p>SEL OSs:</p> <ul style="list-style-type: none"> • RTAC* • Blueframe* <p>Supported third-party OSs:</p> <ul style="list-style-type: none"> • Microsoft Windows 10* • Microsoft Windows Server* • Red Hat Enterprise Linux (RHEL) • CentOS Linux • Ubuntu LTS Linux • SUSE Linux 	Serial	<p>16 RJ45 EIA-232/422/485 ports</p> <p>32 additional RJ45 EIA-232/422/485 ports**</p>
CPU	Intel Atom x5-E3940 quad-core	Digital I/O	<p>1 configurable digital input with analog measurement capability</p> <p>1 Form C digital output with alarm capability</p> <p>24 additional software-configurable digital inputs (6 electrically isolated contact inputs with dedicated returns, 18 electrically isolated contact inputs with common returns)**</p> <p>8 Form A digital outputs (4 Fast Hybrid and 4 standard contact outputs)**</p>
RAM	8 GB DDR3L ECC PC3-1600 (800 MHz)	Time-Code Input/Output	IRIG-B in and out
Mass Storage	<p>Up to two 2.5" SATA III 6.0 Gb/s internal drives that can be optionally populated with the following industrial-grade SSDs:</p> <ul style="list-style-type: none"> • SLC SSD, 32–256 GB, ten-year warranty • Pseudo-SLC (pSLC) SSD, 120–480 GB, five-year warranty • 3D triple-level cell (TLC) SSD, 240–7,680 GB, five-year warranty 	BIOS	AMI UEFI
Video	<p>1 rear DisplayPort 1.2 output for up to 3 displays via DisplayPort 1.2 Multi-Stream Transport (MST)</p> <p>Intel Graphics 500 Controller with maximum resolution:</p> <ul style="list-style-type: none"> • 4096 × 2160 @ 60 Hz, one display • 1920 × 1200 @ 60 Hz, three displays 	Trusted Platform Module (TPM)	Infineon SLM 9670AQ TPM 2.0
Audio	Intel Display Audio, digital audio output on DisplayPort	Power Supply	<p>Built-in power supply with three options to choose from:</p> <ul style="list-style-type: none"> • Low-voltage 24–48 Vdc • Medium-voltage 48–125 Vdc or 110–120 Vac • High-voltage 125–250 Vdc or 110–240 Vac <p>Redundant hot-swappable power supplies**</p>
USB	<p>Two front-panel USB 3.1 ports</p> <p>Four rear USB 2.0 ports</p>	Chassis	Rack or panel mount, 1U or 3U
Ethernet	<p>5 high-speed Gigabit Ethernet ports with the following configuration options:</p> <ul style="list-style-type: none"> • 1 front-panel RJ45 port • 4 rear Ethernet ports configured as one of the following options: <ul style="list-style-type: none"> - 4 RJ45 ports - 4 small form-factor pluggable (SFP) ports - 2 RJ45 and 2 SFP ports 	Operating Temperature Range	–40° to +85°C (–40° to +185°F)
		Other Features	Conformal coating
		Certifications	<p>ISO 9001: Designed, manufactured</p> <p>RoHS</p> <p>CE: CE Mark EMC Directive, Low-Voltage Directive</p> <p>UL, cUL: 61010-1, C22.2 No. 61010-1</p> <p>RCM</p> <p>FCC: 47 CFR 15B, Class A</p> <p>UKCA</p>

*Orderable as a factory-installed option

**Orderable option for 3U model only

SEL SCHWEITZER ENGINEERING LABORATORIES

Making Electric Power Safer, More Reliable, and More Economical
+1.509.332.1890 | info@selinc.com | selinc.com

© 2025 by Schweitzer Engineering Laboratories, Inc.
PF00675 • 20250102

