

SEL-735

Power Quality and Revenue Meter



World-class revenue and power quality metering

- Guaranteed to remain precise for life, eliminating the need for field or factory recalibration.
- One meter for multiple applications. Shares critical information securely with up to ten devices using industry-standard protocols.
- Continuously streams waveform data at a rate of 3 kilosamples per second (ksps) and displays this oscillography on a full-color HMI.
- Captures every power quality (PQ) disturbance with up to 512 load data profile (LDP) channels.
- Improves real-time situational awareness of system conditions using synchrophasor measurements at up to 60 messages per second or 3 ksps of continuous waveform data.



Key Features

Accurate and Reliable Revenue Metering

The SEL-735 Power Quality and Revenue Meter will remain precise for life, exceeding the ANSI C12.20-2015 0.1 and IEC 62053-22 0.1 S accuracy classes over a wide current range—from a few mA to 22 A for power factors (PFs) of 1 and 0.5. With bidirectional, full four-quadrant, and high-accuracy energy metering, the SEL-735 is the ideal meter for generation, interchange, transmission, distribution, or industrial applications. The SEL-735 ensures high-accuracy measurements with a ± 0.06 percent watt-hour (Wh) guarantee at unity power factor and a ± 0.02 percent typical rating.

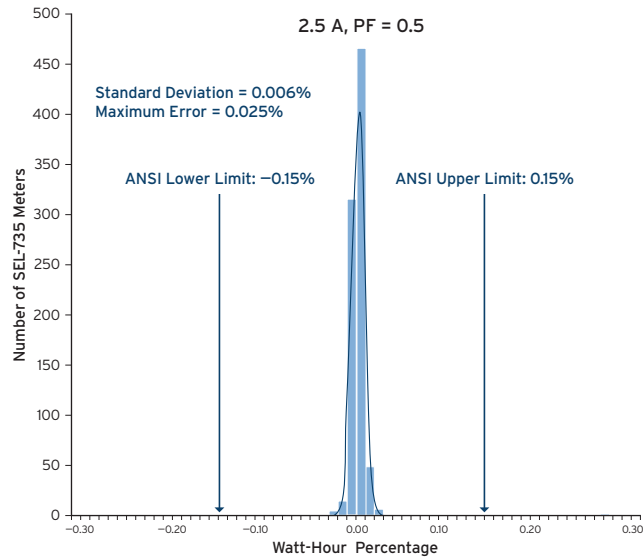

Accuracy-test results of approximately 1,000 SEL-735 Meters report a maximum error of 0.025 percent, outperforming ANSI 0.1 and IEC 0.1 S accuracy class requirements.

The SEL-735 accurately reports energy even in the presence of harmonics and distorted waveforms. When tested with peaked waveform distortion, the SEL-735 reports with an error of just 0.006%.

Voltage Waveform	Current Waveform	0.1 Class Allowable Error %	Measured SEL-735 Error %
Sinusoidal	Sinusoidal	± 0.05	0.003
Sinusoidal	Peaked	± 0.2	0.006
Peaked	Peaked	± 0.3	0.006

SEL-735 performance with peaked waveform distortion.

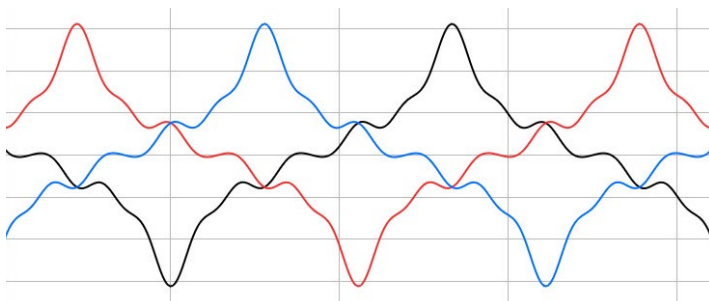

ANSI Test #41: Peaked current waveform.

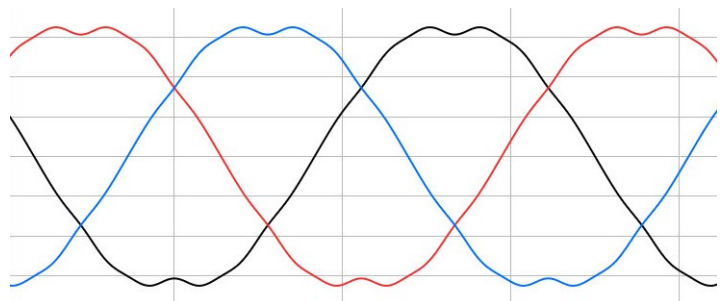

ANSI Test #41: Peaked voltage waveform.

Instrument Transformer Compensation (ITC)

Increase metering accuracy by compensating for instrument transformer errors. The SEL-735 interpolates six user-defined calibration points and corrects ratio and phase errors over the entire measurement range. Compensating for each instrument transformer individually decreases replacement and maintenance costs. With the powerful combination of ITC and IEEE synchrophasors, you can choose to correct delays and errors on each phase to achieve greater system accuracy.

Load Profile Data Collection

Collect and store billing data with a simple-to-use load profile recorder that captures and stores years of data. Independent load profile recorders in the SEL-735 allow simultaneous meter and PQ logging of up to 512 data channels. Averages, minimums, maximums, changes, and snapshots can be trended at a rate of once every three seconds. Analyzing the electrical usage for processes in your facility lets you reduce peak demand. With years' worth of data, you can predict system trends and allocate resources effectively.

Waveform Capture Using Programmable Triggers

Use programmable triggers, such as voltage interruptions, to record up to 10,000 oscillography events. Enabled from the factory, the voltage, sag, swell, and interruption (VSSI) recorder time-stamps voltage excursions with up to 4 ms resolution and records indefinitely using an adaptive sampling rate. With the continuous waveform streaming option, these data are sent to Synchrowave® software at a sampling rate of 3 ksp/s. Settings include trigger thresholds and hysteresis as a percentage of the nominal value and an automatic recording duration dependent on the length of the voltage excursion.

Time-of-Use (TOU) Metering

Capture rate-based demand and energy consumption. TOU metering, configured with a user-defined calendar, allows you to bill consumption at different rates based on season, day type, and time of day. The SEL-735 program automatically reads and resets demand; there is no need to manually reset meters.

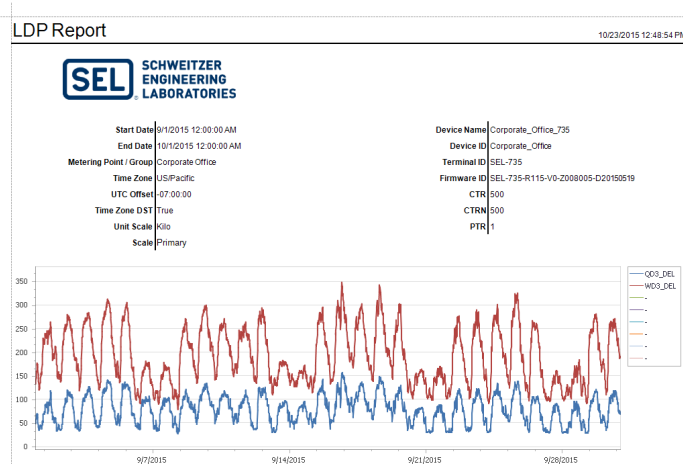

Visualize load profile data.



Capture TOU metering data.

Product Overview



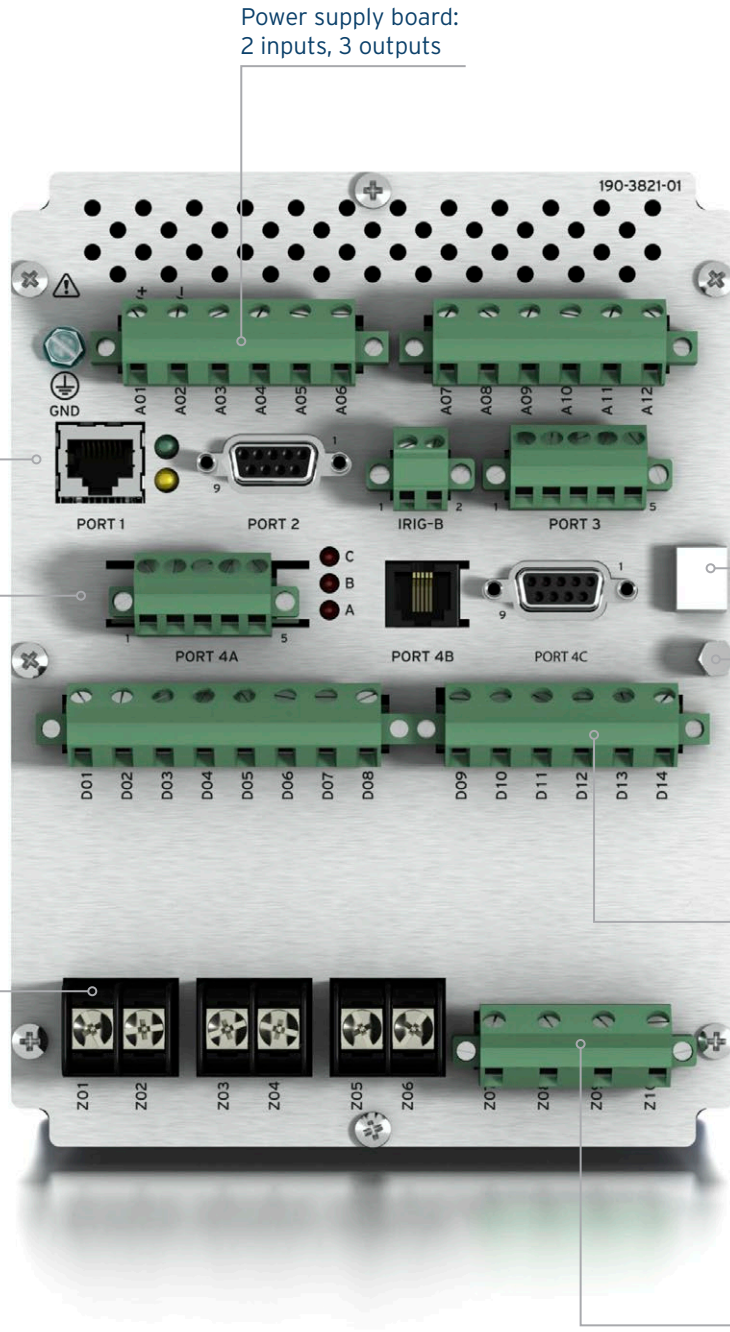

Power supply board:
2 inputs, 3 outputs

Main board: RJ45 copper or
fiber-optic Ethernet, EIA-232,
IRIG-B, EIA-232/-485

Communications board
(Expansion Slot #1): EIA-485,
telephone modem, EIA-232

Sealing provision

I/O board (Expansion Slot #2):
4 inputs, 4 outputs (solid-state
or electromechanical);
or 4 analog outputs,
4 solid-state outputs

CT board: Ia, Ib, Ic

PT board: Va, Vb, Vc, Vn

Touchscreen Overview

Capacitive 5-inch, 800 × 480 color touchscreen

Full onscreen keyboard

Folders and applications to access information

Pushbutton to return to default home screen

Simple Test Mode access

USB Type-C port

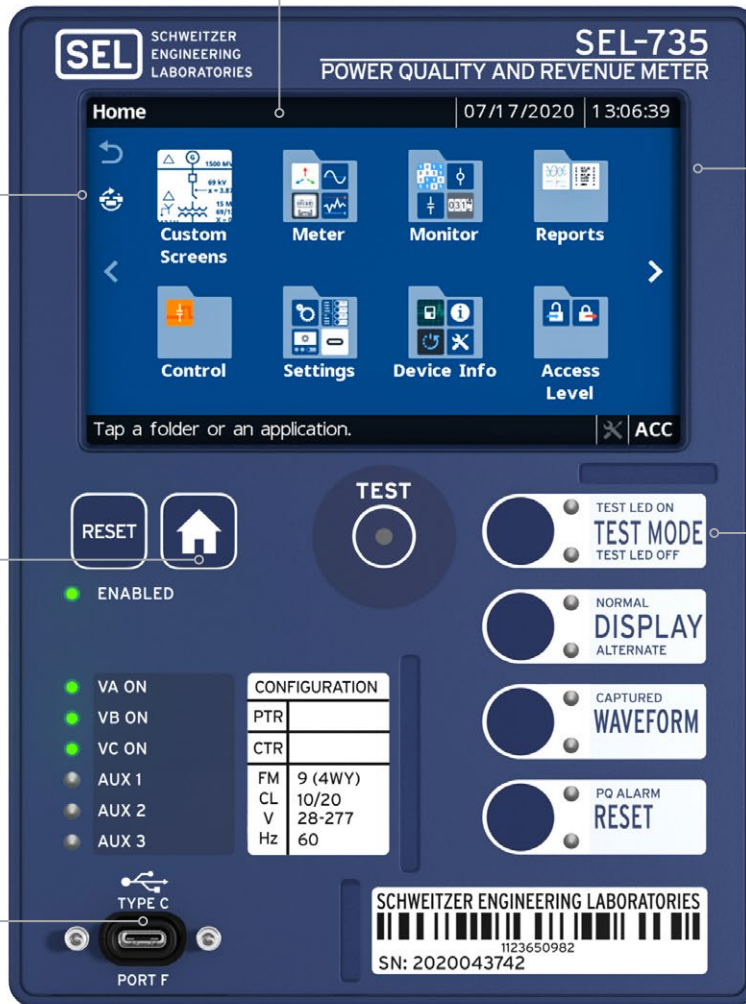

Touchscreen Display Features and Functions

The SEL-735 Meter's 5-inch, 800 × 480 color touchscreen displays high-resolution metering and PQ information without the need for a PC. With it, you can view metered quantities, phasor diagrams, voltage and current waveforms, and more.

Phasor Diagrams

Analyze the real-time voltages and currents in a power system during balanced and unbalanced conditions. This allows you to verify that the system wiring is correct during commissioning, see changes in system conditions as loads vary, and more.

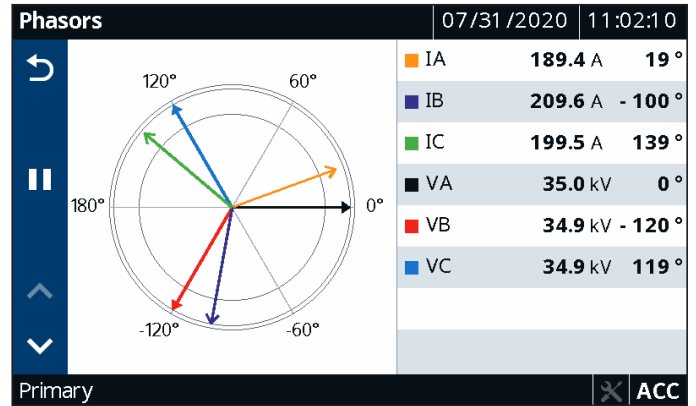

Fundamental Metering

Monitor the power and power factor in your system to measure system efficiency and real-time load flow.

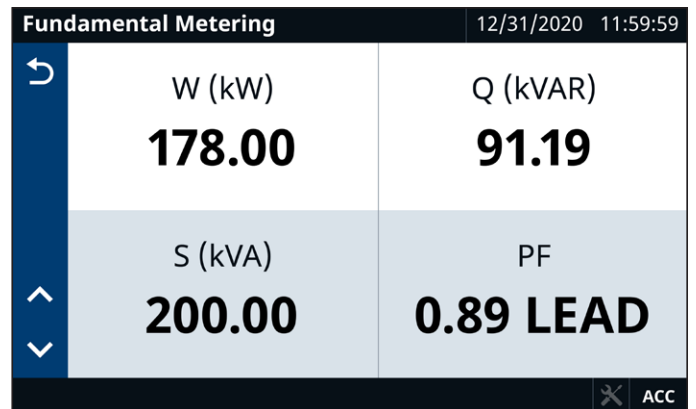

Energy Metering

View the energy metering quantities imported and exported by the system. You can reset the energy values via the display and record the time and date of reset.

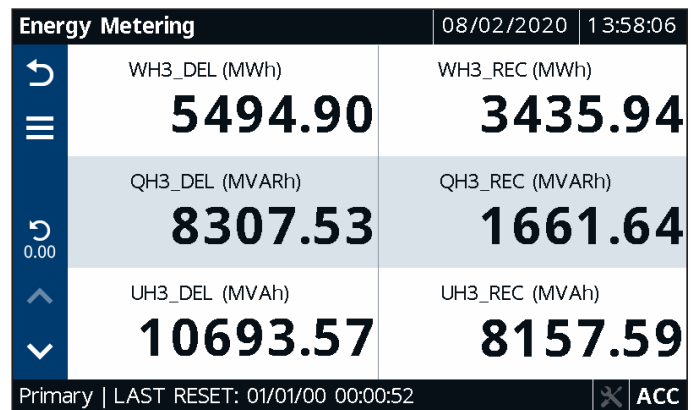

Test Mode

Speed up accuracy testing by visualizing test pulses, accumulated energy, and instantaneous signals. When in Test Mode, the SEL-735 freezes the billing quantities to isolate your test inputs from revenue billing.

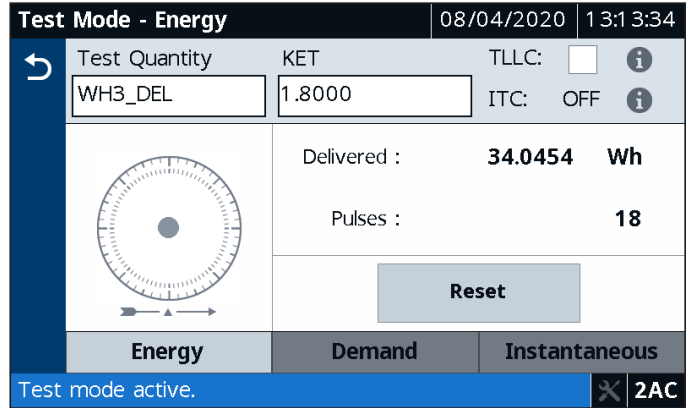

Real-Time Oscilloscope

Display cycle-by-cycle voltage and current waveforms in real time. The Wave View feature offers oscilloscope-like functionality, improving your awareness of system distortions and allowing you to troubleshoot PQ issues that can affect sensitive equipment.

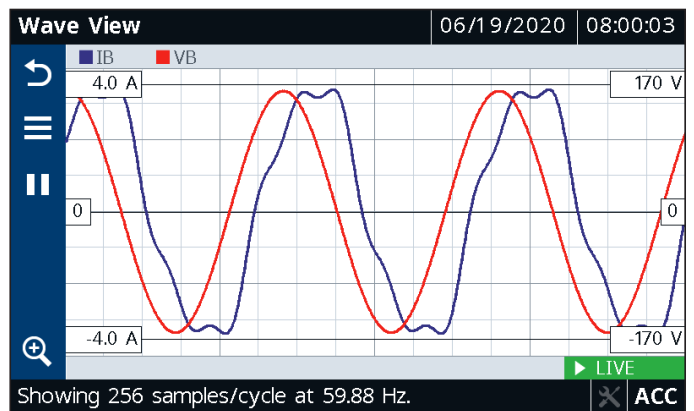

Four-Quadrant Metering

Monitor power and energy accumulation in each delivered/received, lagging/leading quadrant for bidirectional metering. Four-quadrant VAR metering allows you to verify system efficiency.

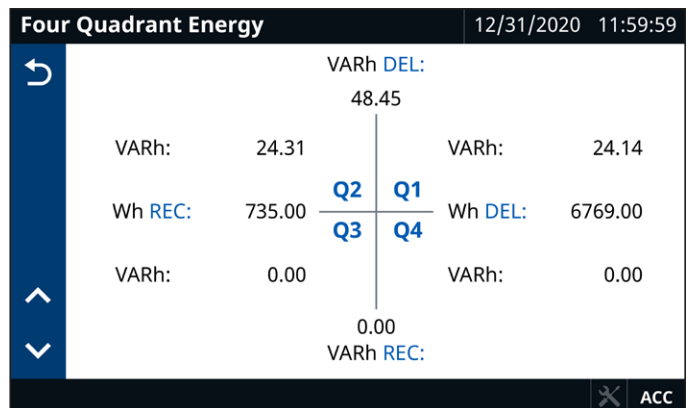

Large Three-Line Display

Continuously monitor all three power system phases from a distance. Customizable screens provide useful defaults, large fonts, and numerous choices for analog quantities.

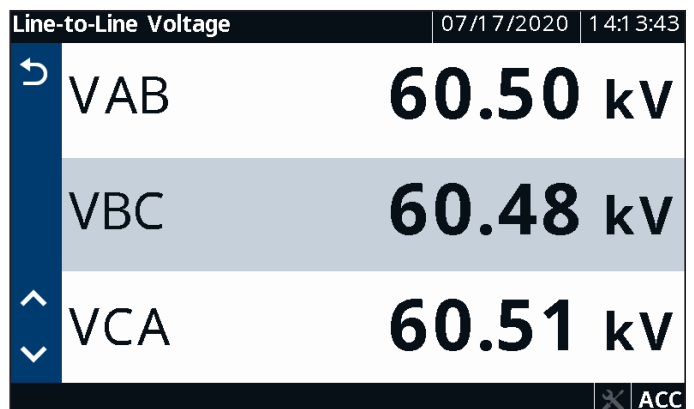

Applications

Grid Stability Improvement

Identify low-frequency system oscillations, monitor intermittent generation in real time, and improve system models with time-aligned data samples. Accurate, high-resolution data can help you identify when an islanded power system can be reconnected to the grid to help stabilize it.

The SEL-735 complies with the latest version of the synchrophasor standard, IEEE C37.118 Class P, making it ideal for applications requiring fast response times under dynamic conditions.

When used as a phasor measurement unit (PMU), the SEL-735 provides synchrophasor data for the frequency and phase, positive-sequence components, 4 user-defined analog quantities, and 16 digital status bits.



Monitor grid conditions with time-aligned synchrophasor messages.

Revenue Metering and Net Billing

The SEL-735 provides flexibility and control for metering applications. The meter can collect and report billing, PQ, and historical data; replace obsolete transducers; and poll directly from SCADA with DNP3 or Modbus protocols. It also supports complex tariffs with multiple load profile data recorders and provides flexible TOU metering with a 20-year calendar. The predictive demand feature provides alarms so you can initiate load control and reduce demand charges.

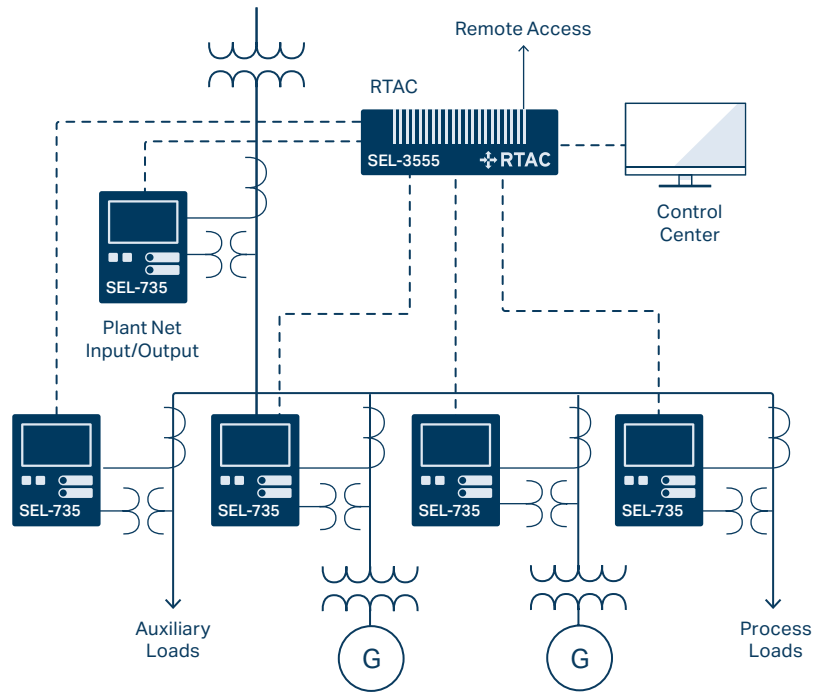

High-accuracy revenue metering and net billing.

Transformer and Line-Loss Compensation

Installing the SEL-735 on the low side of the power transformer reduces instrumentation costs. You can choose from four metering and billing locations to optimize the installation for your needs.

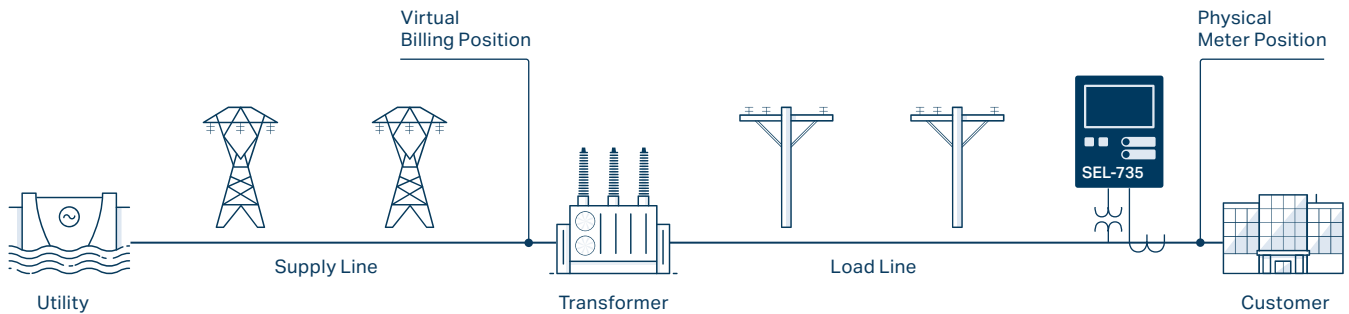

Ensure accurate billing with transformer and line-loss compensation.

Data Streaming and Recording

The SEL-735 captures every disturbance in your power system. Optional continuous waveform streaming precisely samples voltage and current signals at 3 kbps and sends the data to SEL Synchrowave software for visualization. The SEL-735 displays this oscillography in real time on the optional 5-inch color touchscreen. Load profile history is available to view, retrieve, and analyze for years, thanks to the available 1 GB of onboard storage.

The advanced SEL-735 can record the following quantities:

- VSSI with CBEMA/ITI reports
- Symmetrical components
- Measurement aggregation in 3-second, 10-minute, and 2-hour intervals
- Harmonic angles for voltage and current up to the 63rd harmonic
- High-resolution (512 samples/cycle) waveform capture
- High-speed load profile recording with 3-second resolution

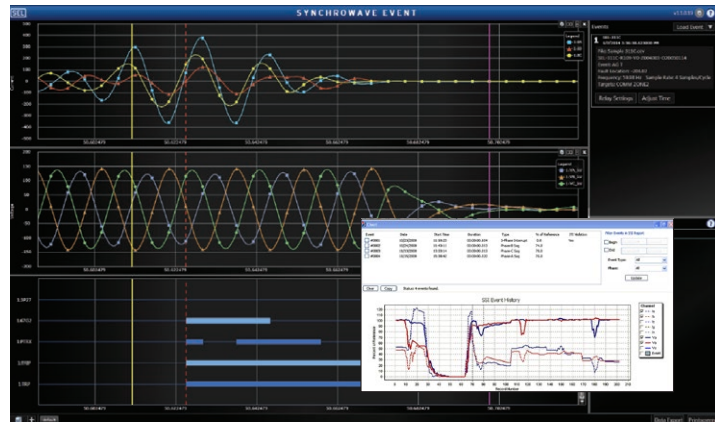

View historical or real-time data with the Synchrowave software suite.

PQ Standards Compliance

Ensure reliable measurements from all compliant devices connected to the same metering points.

- Current, voltage, power, energy, and unbalance data measurements compliant with IEC 61000-4-30 Class A.
- Harmonics and harmonic group measurements as defined by IEC 61000-4-7:2009.
- Monitoring of individual harmonic values, interharmonics from 5 to 3,800 Hz in 5 Hz bins, total harmonic distortion (THD), crest factor, and K-factor.
- Short- and long-term flicker values assessed in accordance with IEC 61000-4-15:2010.
- Three PQ options to fit any application and budget.

Energy Management Optimization

Use SEL-5705 Synchrowave Reports software to better analyze, organize, and share the historical data you collect from SEL meters and other IEDs. Visualize and report on system-wide data, including VSSI; LDP; water, air, gas, electricity, and steam (WAGES) consumption; and Sequential Events Recorder (SER) data. Easily monitor PQ and confirm compliance with the IEEE 519 standard. Synchrowave Reports uses SEL data retrieval software to collect data from SEL meters across the system.

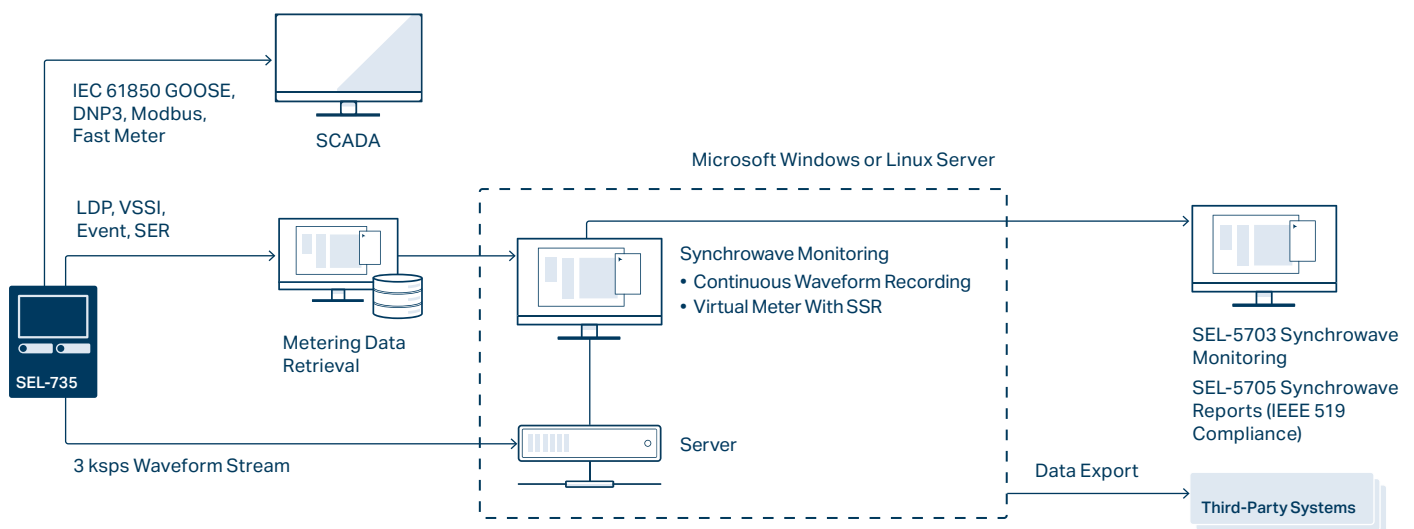

Communications Integration and Security

Advanced communications deliver critical and historical information in real time to virtually any communications system.

Integrate Multivendor Intelligent Electronic Devices (IEDs) With IEC 61850

The SEL-735 optionally supports the IEC 61850 protocol, including GOOSE and MMS, for client/server and peer-to-peer communications, substation design and configuration, testing, and project standards.

Transfer Real-Time Data and Files

Use MMS in IEC 61850 applications to transfer real-time data, including files, within a substation TCP/IP LAN.

Interoperate Using DNP3 and Modbus

Integrate meters with SCADA over DNP3 and Modbus (RTU and TCP/IP) to provide event records, predictive demand alarms, and profile data for analysis.

Monitor the Power System Using Synchrophasors

The SEL-735 with PMU capability allows improved system visualization, real-time situational awareness, and wide-area control. With this capability, you can analyze system topologies and disturbances with simple, accurate, and time-stamped measurements, including root-mean-square (rms) values and digital statuses.

Simplify Metering and Control Using SEL Protocols

The SEL Fast Meter protocol supports binary messages to transfer metering and control messages. The SEL ASCII protocol is designed for manual and automatic communications. MIRRORRED BITS[®] communications is a direct meter-to-meter communications protocol that allows meters to exchange information quickly and securely.

Collect and Manage Data Via Itron MV-90

The SEL-735 provides MV-90 support via the SEL ASCII protocol. Itron MV-90 meter-reading software communicates to any SEL-735 communications port and automates meter reads for large-scale metering installations.

Employ Telnet Communications

Up to six simultaneous Telnet sessions support settings transfer, read device statuses, and automate meter testing over the network.

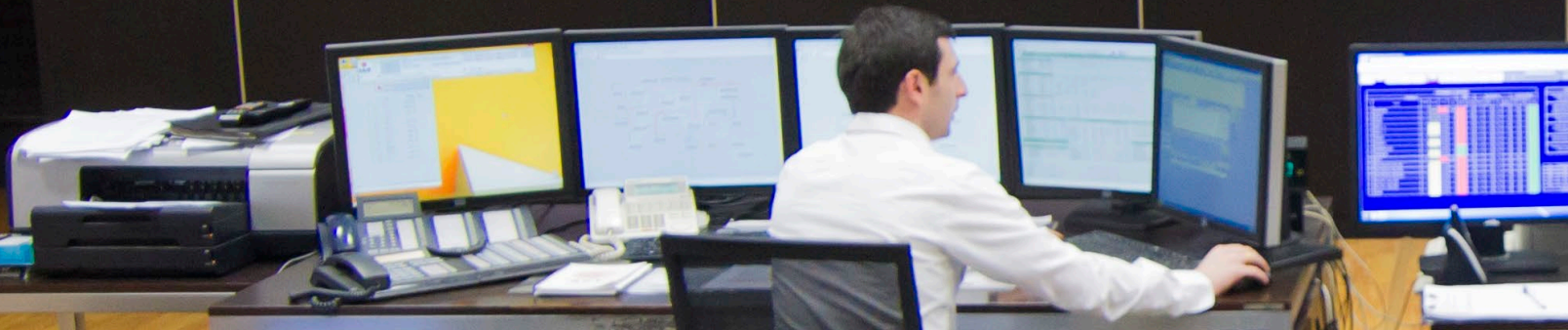
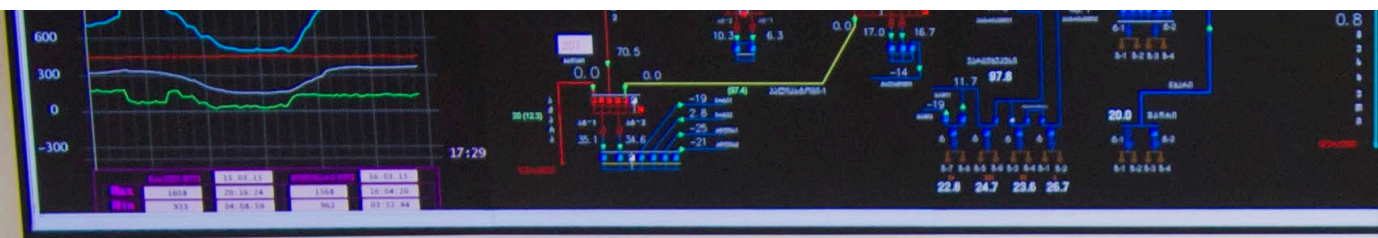

Communicate Data Securely

To limit access to only authorized users, the SEL-735 offers three security levels: read, limited write, and full read/write permission. In addition, port security (PORTSEC) settings can enable or disable individual network protocols and ports to limit access to authorized users. For example, you can configure a secure read-only DNP3 session to an intertie via an EIA-232 serial port. The audit log feature provides traceability on these settings changes, storing up to 72,000 activities with greater detail than typical SER data.

For system-level security, add the SEL-3620 Ethernet Security Gateway for user account management, substation firewall protection, and NERC CIP compliance support. The SEL Real-Time Automation Controller (RTAC) provides secure, encrypted communications and works as a remote intelligence gateway. Cryptographically signed firmware helps ensure that nothing compromises the meter integrity.

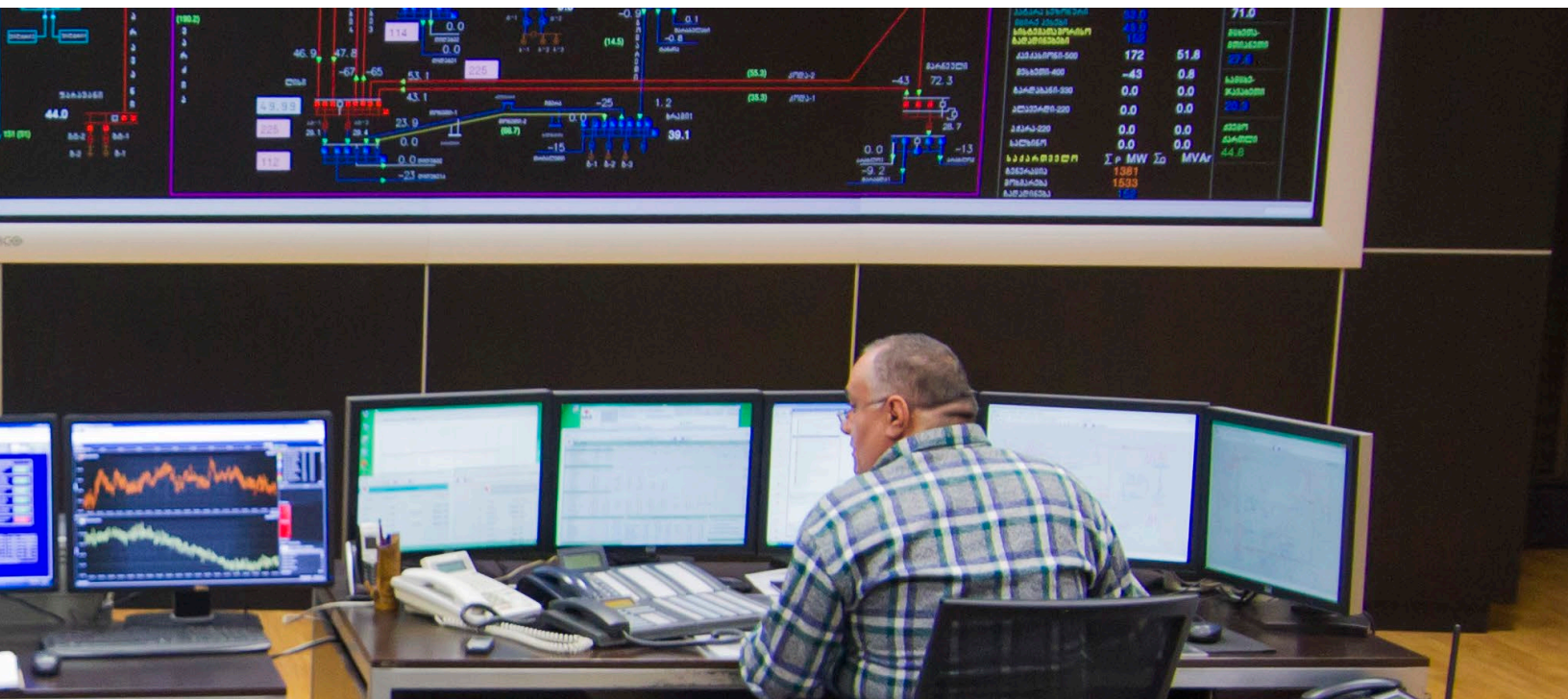
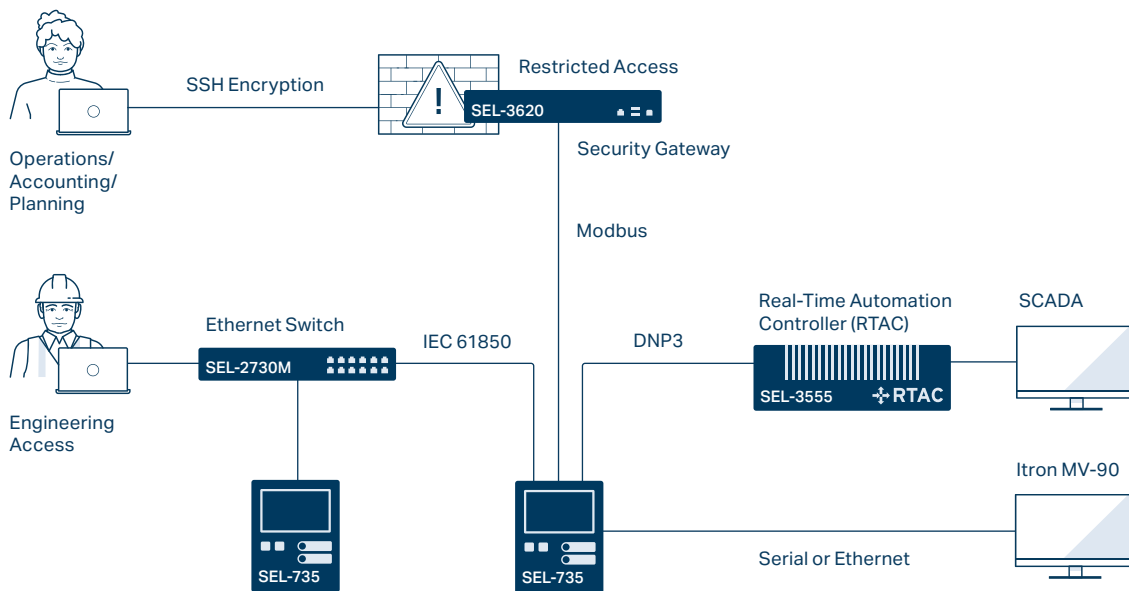

Flexible Installation

Outdoor Enclosure

Replace socket meters with a low-cost enclosure and prewired FT-1 test switch. You can quickly install the meter with the support of thoughtful design details, such as DIN rails for accessories; a lockable, stainless-steel latching system; wall-mount brackets; prewiring from meter to test switch; and wire clamps. The fully sealed enclosure complies with NEMA 4X, IEC 529, and IP66 protection requirements.



Outdoor Enclosure Mounting

Mounting Options and Accessories

Refer to the SEL-735 Accessories Catalog, available at selinc.com/literature/product-catalogs, for more information on brackets, retrofit bezels, cover plates, and other accessories.



Kit 915900136



Kit 915900063



Horizontal Meter and Test Switch

Vertical Bezels

Easily Extractable Meter (EXM)

The EXM option offers the following benefits:

- Meter extraction in less than one minute.
- Improved safety versus draw-out and socket meters.
- Self-shorting CT connector.
- Clearly marked wires.
- Easier installation at half the cost of a draw-out meter.
- Simplified field testing with integrated connectors.
- Simple retrofit brackets for replacing draw-out meters.



1 Pull quick-release latches.



2 Hinge meter down.

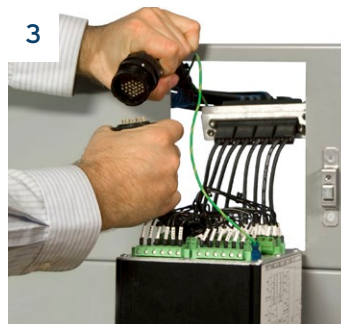

3 Remove quick disconnects.



4 Easily extract the meter.

Portable PQ Meter

Monitor PQ anywhere with the rugged SEL-735 Portable Power Quality Meter. You can pinpoint PQ problems and energy consumption on subcircuits with clamp-on CTs and clip-on voltage leads. In addition, the portable meter lets you log years' worth of data with 1 GB of onboard memory.



SEL-735 Specifications

General	
Displays	Customizable three-line or single-line display 5-inch color touchscreen display, 800 × 480 pixels
AC Current Inputs	Current Class CL2/CL10/CL20, optimized for low-end accuracy Measurement: 0.001–22 A continuous Current Class CL10/CL20, optimized for 100 A fault recording Measurement: 0.005–22 A continuous; 22–100 A symmetrical
AC Voltage Inputs	Revenue: 28–300 V _{L-Nr} , 48–520 V _{L-L} Measurement: 5–300 V _{L-Nr} , 9–520 V _{L-L} Burden: 10 MΩ
I/O Options	4 digital inputs, 4 digital outputs (solid-state or electromechanical) 4 analog outputs, 4 solid-state digital outputs
PQ Options	Basic: 128 MB of memory, 16 channels of LDP, 16 samples per cycle waveform, and 15th-order harmonics Intermediate: 256 MB of memory, 192 channels of LDP, 128 samples per cycle waveform, 270 VSSI summary events, flicker, and 63rd-order harmonics Advanced: Intermediate features and 1 GB of memory, 512 channels of LDP, 512 samples per cycle waveform, 600 VSSI summary events, Wave View, power harmonics, and interharmonics
Processing	AC voltage and current inputs: 512 samples per power system cycle Control processing: half-cycle processing interval
Energy Accuracy (Form 5 and Form 9 Only)	ANSI C12.20 0.1 Accuracy Class IEC 62053-22 Accuracy Class 0.1 S IEC 62053-23 Accuracy Class 2 S
Communications Modes	Up to ten simultaneous communications sessions via EIA-232 serial, EIA-485/EIA-422 multidrop, infrared, and copper or fiber-optic Ethernet
Communications Protocols	SEL ASCII/Compressed ASCII, SEL Fast Operate/Fast Meter, MIRRORING BITS communications, SEL Distributed Port Switch (LMD), Modbus RTU/TCP, DNP3 Serial and LAN/WAN, FTP, TCP/IP, Simple Network Time Protocol (SNTP), IEC 61850, Telnet, Itron MV-90, IEEE C37.118.1a-2014 synchrophasors, and Continuous Waveform Streaming Protocol
IEEE C37.118 Synchrophasors	Up to 60 messages per second (60 Hz system)
Power Supply	125/250 volt supply: 85–264 Vac (50/60 Hz), 85–275 Vdc 24/48 volt supply: 19–58 Vdc 12/24 volt supply: 9.6–30 Vdc (not available on the color touchscreen meter)
Frequency and Rotation	60 Hz or 50 Hz system frequency specified at time of order; user-selectable ABC/ACB phase rotation
Operating Temperature	–40° to +85°C (–40° to +185°F)
Panel-Mount Dimensions	Standard: 192 mm × 144 mm × 148 mm EXM: 214 mm × 211 mm × 136 mm

SCHWEITZER ENGINEERING LABORATORIES

Making Electric Power Safer, More Reliable, and More Economical
+1.509.332.1890 | info@selinc.com | selinc.com

© 2024 by Schweitzer Engineering Laboratories, Inc.
PF00646 • 20241002

