

Application Guidelines for Power Swing Detection on Transmission Systems

Joe Mooney and Normann Fischer
Schweitzer Engineering Laboratories, Inc.

Presented at the
42nd Annual Minnesota Power Systems Conference
Saint Paul, Minnesota
November 7–9, 2006

Previously presented at the
60th Annual Georgia Tech Protective Relaying Conference, May 2006,
59th Annual Conference for Protective Relay Engineers, April 2006,
and 5th Annual Clemson University Power Systems Conference, March 2006

Originally presented at the
32nd Annual Western Protective Relay Conference, October 2005

Application Guidelines for Power Swing Detection on Transmission Systems

Joe Mooney, P.E. and Normann Fischer, Schweitzer Engineering Laboratories, Inc.

Abstract—Power swing detection on transmission systems is becoming more critical. Traditionally, setting relays for power swing blocking (PSB) or power swing tripping applications has been very complex and time consuming. In many cases, the settings are not correct, which is discovered when the relay operates incorrectly.

This paper provides the reader with practical setting and application guidelines for traditional impedance-based PSB schemes. It shows how to set a PSB scheme without stability studies. Highlighted are some problem areas when setting and applying power swing detection elements. Application of these setting guidelines will be demonstrated using a power system modeled on a real-time digital simulator.

I. REVIEW OF POWER SYSTEM STABILITY

There are many textbooks and technical documents describing power system stability. Following is a brief review based on the description in [1].

If we neglect resistance, the amount of power (P) transmitted in the simple system shown in Fig. 1 can be represented by the following equation:

$$P = \frac{|E_S| \cdot |E_R|}{X} \cdot \sin(\delta) \quad (1)$$

where:

- E_S is sending end voltage
- E_R is receiving end voltage
- δ is the angle by which E_S leads E_R
- X is the total reactance between the sending and receiving end voltages

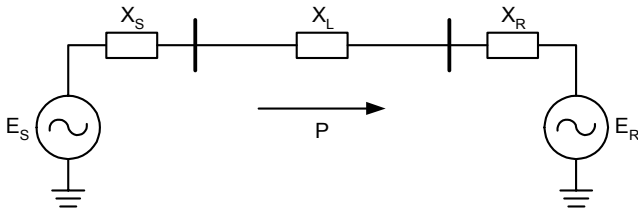

Fig. 1. A Two-Source System

With fixed E_S , E_R , and X values, the relationship between P and δ can be described in the Power Angle Curve shown in Fig. 2. It can be seen from Fig. 2 that the power transfer increases as δ increases. Maximum power transfer is reached when δ is 90 degrees. Beyond 90 degrees, the amount of power transfer decreases as δ increases. Under normal operating conditions, the mechanical input power is converted to an equivalent amount of electrical power that is transferred over the line. The angle difference under normal conditions is δ_0 .

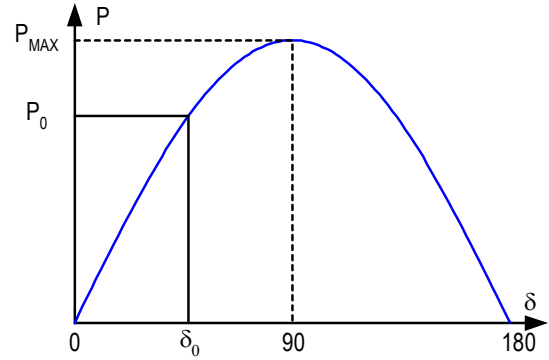

Fig. 2. Power Angle Curve Showing Operating Conditions and Maximum Power Transfer Capabilities

The generator rotor also turns at a constant speed under normal operating conditions, thus maintaining a constant system frequency. If a major disturbance occurs, such as a fault, the electrical power output of the generator suddenly decreases. Because the mechanical input to the generator cannot instantly decrease, the generator begins to accelerate unless other control action takes place to reduce the mechanical input.

Assume that the system shown in Fig. 1 is operating at P_0 and δ_0 . During a fault, the electrical output required of the generator is reduced to P_F (see Fig. 3) and the generator rotor begins to accelerate. This increases δ , because the mechanical input to the generator has not changed. When the fault is cleared, the generator angle has increased to δ_C , the electrical power output of the generator is greater than the mechanical input, and the generator begins to decelerate. However, the inertia of the rotor causes the angle to continue to increase to δ_F , and the energy lost in Area 2 is equal to the energy gained in Area 1. This is referred to as the Equal Area Criteria.

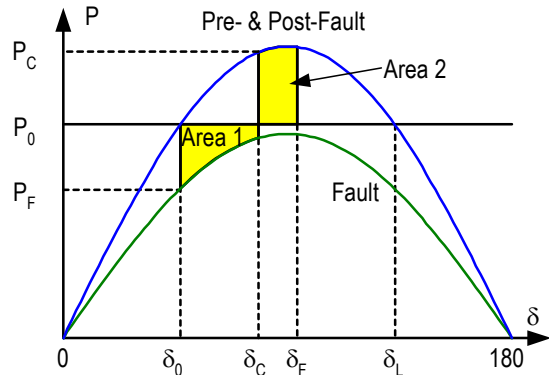

Fig. 3. Clearing Time for Transiently Stable System

If δ_F is smaller than δ_L , then the system is transiently stable as shown in Fig. 3, and the system will eventually reach a stable operating condition at δ_0 or some other angle. If Area 2 is smaller than Area 1, then the angle will continue to increase to δ_L . When the angle increases to δ_L and beyond, the electrical power output is less than the mechanical input and the angle continues to increase. This is a transiently unstable condition as shown in Fig. 4. When the system is unstable, one of the equivalent generators rotates at a different speed than the other generator. This condition is considered an unstable power swing or out-of-step condition.

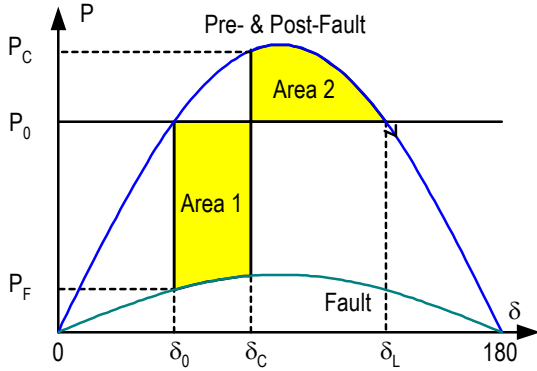

Fig. 4. Slow Clearing Time Make the System Unstable

II. POWER SWING DETECTION METHODS

A. Traditional

Traditional impedance-based characteristics for detecting power swings on a transmission system are shown in Fig. 5a, Fig. 5b, and Fig. 5c. All of these methods involve measuring apparent impedance and timing between two measuring elements. The impedance measurement is typically a phase-phase impedance, where all three phase-phase loops are required for operation, or it is a positive-sequence impedance.

A timer is started when the apparent impedance enters the outer characteristic (see Fig. 5a). If the apparent impedance remains between the inner and outer characteristics for the set time delay, the PSB element operates and selected distance element zones are blocked from operation for a period of time.

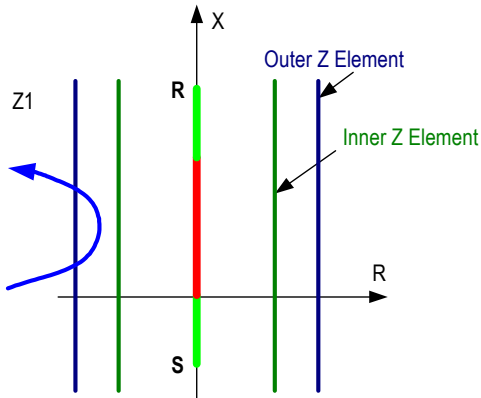

Fig. 5a. Double Blinder Impedance-Based Power Swing Detection Characteristic

An out-of-step tripping scheme may use the same measuring element or a different set of measuring elements. The gen-

eral operation is similar to PSB except the expected behavior is that the apparent impedance passes through both the inner and outer characteristic (see Fig. 5b). A timer determines if the change in impedance is a result of a fault or a power swing. If it is an unstable power swing, then one can select tripping on the way into the characteristic or on the way out of the characteristic. Selection of tripping on the way in or on the way out is determined from numerous stability studies and the ability of the circuit breakers to isolate the circuit with a significant voltage angle across the breaker.

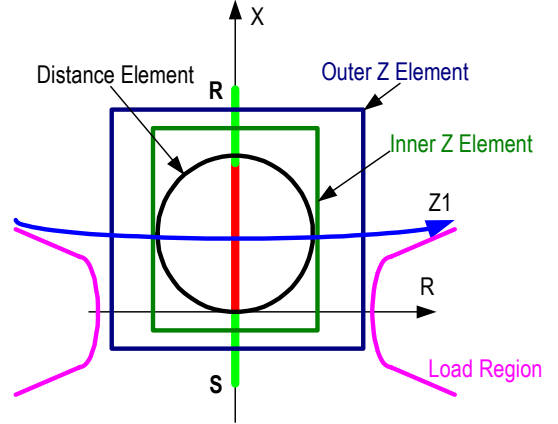

Fig. 5b. Quadrilateral Impedance-Based Power Swing Detection Characteristic

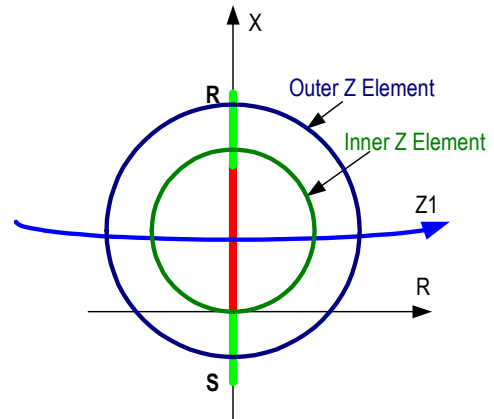

Fig. 5c. Offset Mho Impedance-Based Power Swing Detection Characteristic

B. Advanced

The advent of digital technology has given relay design engineers the ability to develop and implement new methods for detecting power swings. A number of the new techniques do not require user-entered settings, thus greatly simplifying the application of power swing detection and protection [2] [3]. Others still require study, which can sometimes be very extensive and time consuming.

Some of these new methods involve measuring the rate of change of resistance or impedance to determine if the system is experiencing a power swing [3] [4] [5]. Other methods estimate the swing center voltage and its rate of change, and from these estimates determine if there is a power swing, and take the appropriate action [2].

Synchronized phasor measurement has also been proposed as a way to detect and take action for power swings [6]. Many utilities are currently evaluating the use and application of

synchronized phasor measurement systems. As this technology develops, new and innovative methods of power swing detection are sure to be developed.

III. APPLICATION OF POWER SWING DETECTION RELAYS

Determining if a power swing relay is required at a particular location on the power system can be a difficult task. For the most part, stability studies are required to locate the critical points on the power system and to gauge the system stability margins [1] [7]. In some cases, power swing relays are applied based on historical data, i.e., where the system has previously had a power swing condition that resulted in an undesired operation.

In some power swing tripping applications, the locus of the power swing may not be the ideal location for separation. Therefore, extensive stability studies must be performed to determine the best location for detection of the swing and the best location for separation [1] [7].

IV. SETTING THE POWER SWING BLOCKING SCHEME

Setting a power swing element is typically accomplished by extensive and time-consuming stability studies. Although using the stability study to set the power swing element is the best method, power swing elements can also be set by using known system conditions and making certain assumptions about the behavior of the power system. These methods work well for PSB schemes but do not work well for out-of-step tripping.

There are many publications that describe setting power swing elements using known system parameters [7] [8] [9] [10] [11]. Using an impedance-based setting method works well for most applications, particularly those where there are not significant changes in the source and transfer impedances.

Reference [7] outlines a method of setting power swing elements by determining the equivalent source and transfer impedances in the area of interest. A fault study program is a useful tool in calculating the equivalent source and transfer impedances. When developing these equivalent systems, one must consider the proximity of generation, strong interconnects, and various switching conditions that would significantly impact the equivalent impedances.

For example, [7] recommends using the boundary equivalent function, offered in most fault study programs, by removing the line of interest. For most applications, this method would work well. However, in most fault study programs, the generator impedances are represented using the subtransient reactance of the unit. During a power swing, the generator is operating within the transient and/or synchronous impedance characteristic, both of which can have a significantly greater impedance than the subtransient impedance. Therefore, one must be sure that the correct impedances are represented when calculating the system equivalents.

Once the equivalent impedances are calculated, another piece of information is required—the power swing slip rate. Again, the best way to determine the slip rate is by performing stability studies; however, if that is not possible, a typical maximum power swing slip rate between 4 and 7 Hz may be

selected [7]. The slip rate is equivalent to the rate at which the system is oscillating or the rate of change of impedance as viewed from the relay location.

The location of generation with respect to the relay location can also directly impact the slip rate. The number and size of local generation can impact the equivalent inertia of the power system or the rate of oscillation. This is in addition to the ability of the system to remain in a stable operating mode.

References [7] [8] describe a method for setting the inner and outer resistive blinders, given the system source impedances and the power swing slip rate. Two methods can be used to determine the blinder settings:

1. Select the inner blinder setting to be outside of the furthest reaching distance element that is supervised by the PSB element. Select the outer blinder setting to be inside maximum load flow. Both the inner and outer blinder settings should be set with adequate margin. Use a margin of about 20 percent to ensure secure operation.
2. Select the power angle for the inner and outer blinders using the system equivalent impedance data as shown in Fig. 6. Select the inner and outer blinder power angles to allow adequate margins as stated in Method 1.

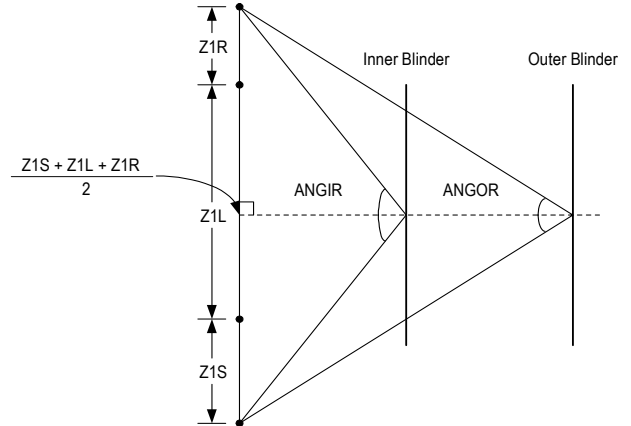

Fig. 6. Equivalent Source Angles During Power Swing

The PSB time delay is determined from the selected blinder settings and the estimated power swing slip rate as follows:

$$PSBD = \frac{(ANGIR - ANGOR) \cdot Fnom}{360 \cdot SlipF} \quad (2)$$

where:

PSBD	is the PSB setting in cycles
ANGIR	is the inner resistive blinder
ANGOR	is the outer resistive blinder power angles in degrees
Fnom	is the system nominal frequency in Hz
SlipF	is the power swing slip rate in Hz

In addition, the PSB delay should represent a “reasonable” time delay. The selected time delay should allow the scheme enough time to make a secure decision without impacting the operation of the PSB element. In particular, for a power swing detection element that uses a positive-sequence impedance measurement, the positive-sequence impedance travels through the power swing characteristic for faults, load

changes, and other system operating conditions. We recommend a PSB delay in the 1.5 to 2.5-cycle range to ensure that the PSB element does not operate for normal conditions.

Using Method 1 for selecting the inner and outer blinder settings requires an alternate form of Equation 2 to determine the PSB delay. Calculate the power angles from the selected settings and the system impedance information as follows, and use the results as input to Equation 2:

$$ANGIR = 2 \cdot \text{atan} \left(\frac{|ZT|}{2 \cdot INBR} \right) \quad (3)$$

$$ANGOR = 2 \cdot \text{atan} \left(\frac{|ZT|}{2 \cdot OTBR} \right) \quad (4)$$

where:

- ANGIR is the inner blinder power angle in degrees
- ANGOR is the outer blinder power angle in degrees
- ZT is the total system impedance between the equivalent sources ($Z1S + Z1L + Z1R$) in ohms secondary
- INBR is the inner blinder resistive reach setting in ohms secondary
- OTBR is the outer blinder resistive reach setting in ohms secondary

Power swings cause a significant change in the apparent resistance; therefore, the swing impedance typically enters the power swing characteristic via the left-hand or right-hand resistive blinders. When using an impedance characteristic like that shown in Fig. 5b, the setting selected for the “top” and “bottom” of the power swing characteristic is not critical. We recommend that the settings be near the maximum setting that the relay offers or two to three times the maximum distance element reach. It is also beneficial to set the top and bottom characteristics to the same values. Using these settings provides very complete coverage of the protected elements.

V. POWER SWING BLOCKING EXAMPLE APPLICATIONS

A. System Example 1

Appendix A shows an example system for evaluating the performance of a PSB element using the impedance-based settings method. The PSB relay is located at the Bus D terminal of Line 7. The equivalent source impedances assume that Line 1 is out of service, because a fault and clearing of the fault on that line cause the power swing condition.

The PSB element in this example measures positive-sequence impedance and uses an impedance characteristic like that shown in Fig. 5b. We select the inner and outer resistive blinder reach settings using Method 1. We determine the power angles using the equivalent system source impedance and line data. The inner and outer blinder settings are adjusted to meet the criteria described in Method 1 and to provide a PSB delay between 1.5 and 2.5 cycles. The left-side resistive blinders are set equal to the right resistive blinders.

The nominal operating voltage for this system is 230 kV. The voltage transformer ratio is 2000/1. The current trans-

former ratio is 1000/5. Maximum load is 1000 amps at a ± 30 -degree power factor. The Zone 1 and Zone 2 distance element reaches are set to 85 percent and 130 percent of the line impedance, respectively.

An off-the-shelf short-circuit program is used to calculate the equivalent source impedances as recommended in [7]. The equivalent source impedances and line impedance, in secondary ohms, are as follows:

$$Z1S = 3.12 @ 86.9^\circ \Omega$$

$$Z1R = 1.97 @ 87.7^\circ \Omega$$

$$Z1L = 3.19 @ 84.3^\circ \Omega$$

The PSB settings are calculated using a MathCAD file shown in Appendix C. Using a maximum power swing slip rate of 4 Hz, the settings are as follows:

$$INBR = 3.5 \Omega$$

$$OTBR = 7.5 \Omega$$

$$PSBD = 1.75 \text{ cycles}$$

Fig. 7 is a plot of the distance element and power swing characteristics.

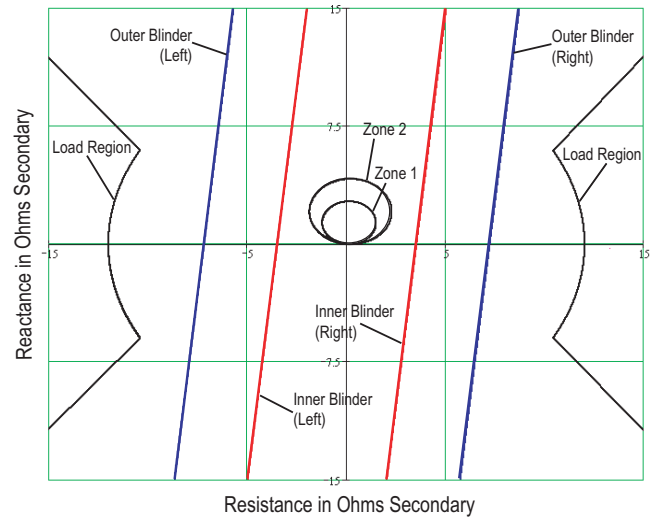

Fig. 7. Impedance Plot of Example Power Swing Blocking Settings

A three-phase fault is applied for 100 ms on Line 1 near Bus B. Line 1 is opened and closed 19 seconds after the fault is cleared to maintain system stability. The open interval is adjusted to maximize the power swing impedance trajectory without causing the system to go unstable.

Data are captured over a 60-second time frame in a COMTRADE format. The COMTRADE file is played back using a model of the PSB relay implemented in MathCAD. The model replicates the exact operation of the relay including the digital filtering and processing rate.

Fig. 8 is a plot of the current and voltage over the entire 60-second window.

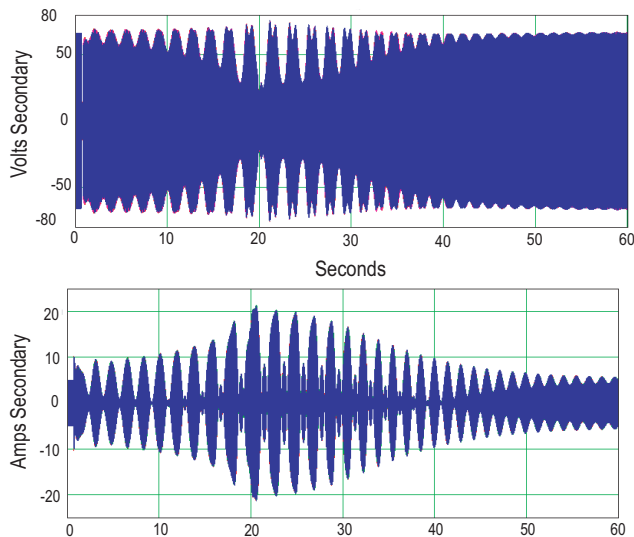

Fig. 8. Secondary Voltage and Current Plots of Entire Swing Case

Fig. 9 is a plot of the positive-sequence impedance trajectory and the power swing and distance element characteristics. This plot shows the entire 60-second data capture.

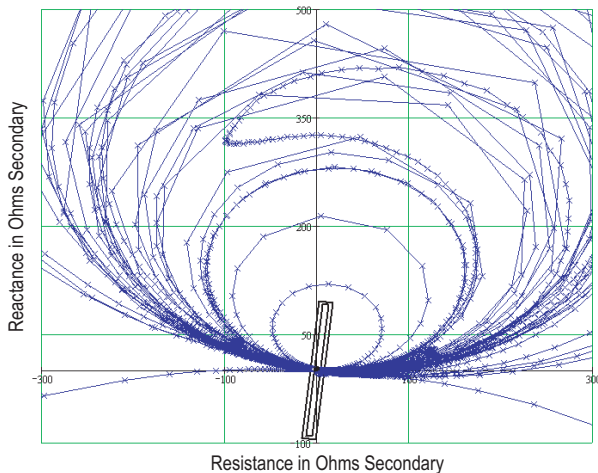

Fig. 9. Positive-Sequence Impedance Plane Plot of Entire Swing Case

Fig. 10 is a zoomed-in version of Fig. 9 that shows the positive-sequence impedance entering the power swing and distance element characteristics.

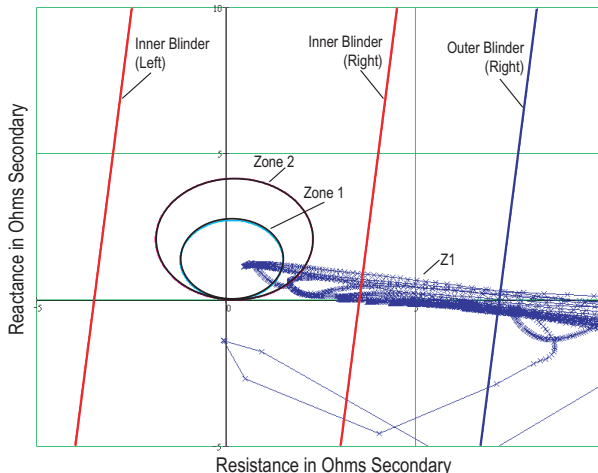

Fig. 10. Zoomed-In Positive-Sequence Impedance Plane Plot

Fig. 11 is a logic plot showing operation of the PSB element, the inner and outer blinder elements, and the phase distance elements.

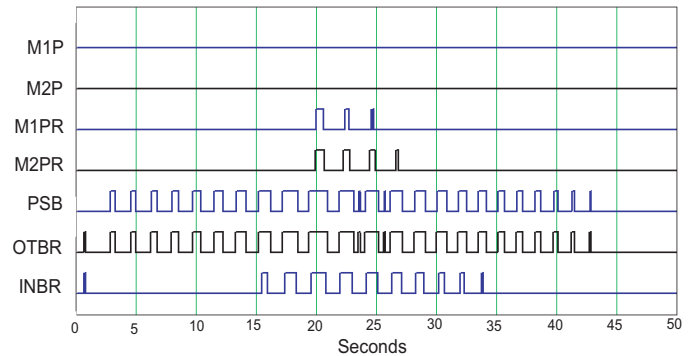

Fig. 11. Logic Output of Power Swing Blocking and Distance Elements

The output of the inner and outer blinder elements are shown as INBR and OTBR, respectively. We can see the blinder elements operating any time the positive-sequence impedance enters the characteristic. The short pickup earlier in the event is the three-phase fault on Line 1. Subsequent operations are caused by the power swing. The PSB variable is the output of the PSB logic. The M1PR and M2PR variables are the output of the Zone 1 and Zone 2 distance element logic without the PSB supervision but including all other supervision (directional element, fault detectors, etc.). The M1P and M2P variables are the final output of the distance element logic that includes the PSB supervision. Note that there is no output from the M1P and M2P variables.

B. System Example 2

Appendix B shows a system was developed and validated for performance testing of a protective relay system by BC Hydro. The power swing detection relay is located at the TKW terminal of the TKW-SKA 500 kV line.

The nominal operating voltage for this system is 500 kV. The voltage transformer ratio is 4500/1. The current transformer ratio is 3000/5. The Zone 1 and Zone 2 distance element reaches are set to 85 percent and 150 percent of the line impedance, respectively.

System equivalent impedances are calculated with all sources and lines in service. The equivalent source impedances and line impedance, in secondary ohms, are as follows:

$$Z1S = 16.1 @ 85.5^\circ \Omega$$

$$Z1R = 26.95 @ 87.4^\circ \Omega$$

$$Z1L = 6.4 @ 85.4^\circ \Omega$$

The PSB settings are calculated using a MathCAD file shown in Appendix C. The inner resistive blinder is set to 120 percent of the maximum Zone 2 resistive reach, which results in a 6 ohm setting. The outer blinder is adjusted to provide a 1.5-cycle PSB delay given a maximum assumed slip rate of 5 Hz. The settings are as follows:

$$INBR = 6 \ \Omega$$

$$OTBR = 18 \ \Omega$$

$$PSBD = 1.5 \text{ cycles}$$

Note that the outer blinder may encroach upon maximum load flow. At nominal voltage levels, and a ± 30 -degree power factor, load greater than 1500 MVA encroaches into the power swing characteristic. For this example, the maximum load flow is well below 1500 MVA.

Fig. 12 is a plot of the distance element and power swing characteristics.

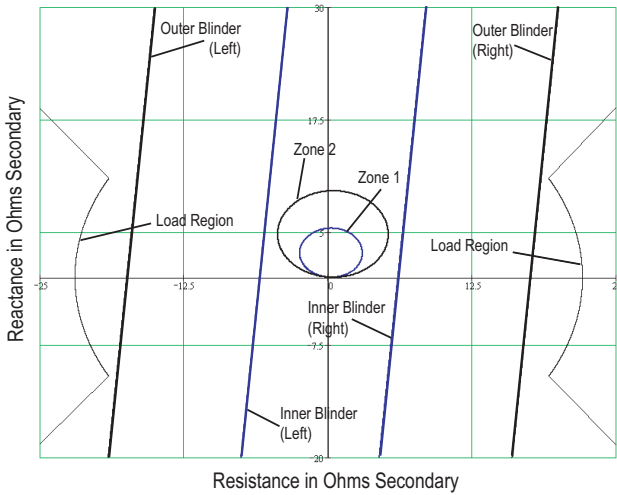

Fig. 12. Impedance Plot of Example B Power Swing Blocking Settings

The power swing is caused by application of a three-phase fault on the SKA287 bus. The system remains stable if the fault is applied for less than 133 ms. The results are saved and played back in the same manner as Example A.

Fig. 13 shows the current and voltage plots ever the entire 20-second window.

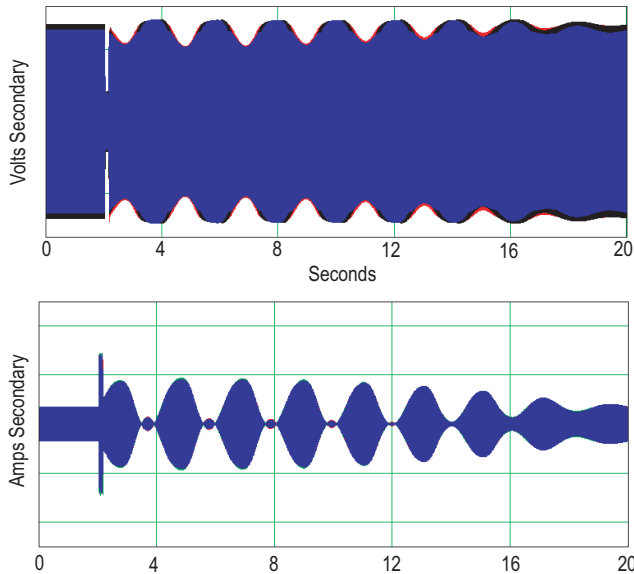

Fig. 13. Secondary Voltage and Current Plots of Stable Power Swing Case

Fig. 14 is a plot of the positive-sequence impedance trajectory, the PSB element, and distance elements. This plot shows the entire 20-second data capture.

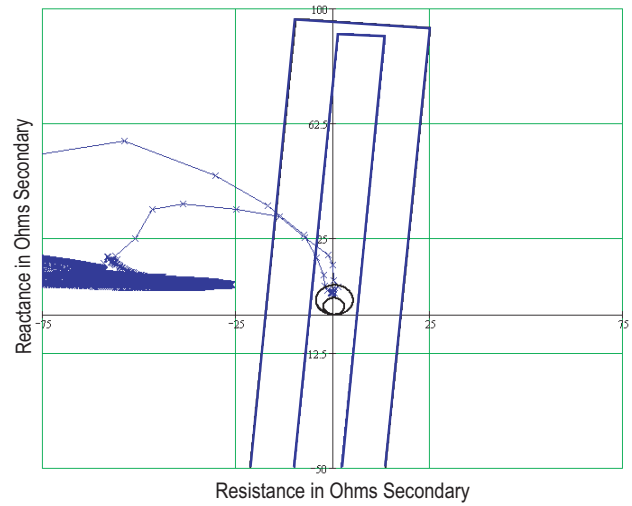

Fig. 14. Positive-Sequence Impedance Plane Plot of Stable Power Swing Case

This system turned out to be a rather interesting test case because a stable power swing did not enter the impedance characteristic of either the PSB or distance elements. Therefore, a PSB scheme is not required on this system. However, in order to test the application, we decided to simulate an unstable power swing without changing any settings. The purpose of applying the unstable power swing is to prove that the power swing is detected and the scheme would block operation of the distance elements.

Fig. 15 shows the current and voltage plots for the unstable swing condition. Note that the system went unstable when the fault was applied for 135 ms.

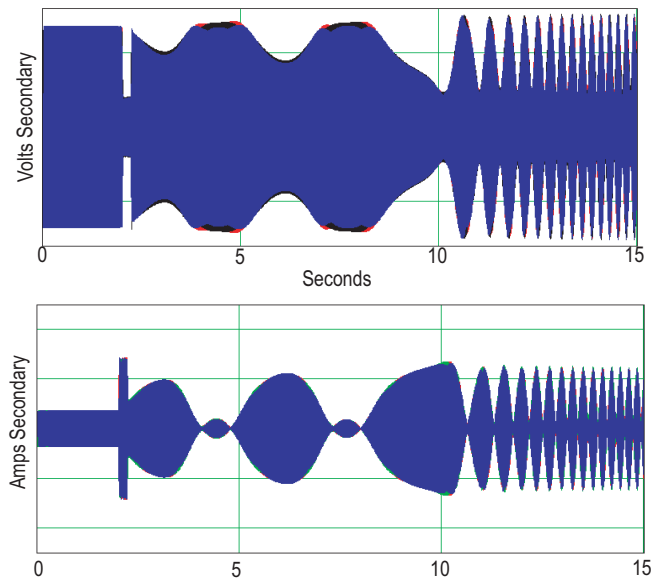

Fig. 15. Secondary Voltage and Current Plots of Unstable Power Swing Case

Fig. 16 is a plot of the positive-sequence impedance trajectory and the power swing and distance element characteristics. This plot shows the entire 15-second data capture. Note that the impedance trajectory goes through the distance element characteristic.

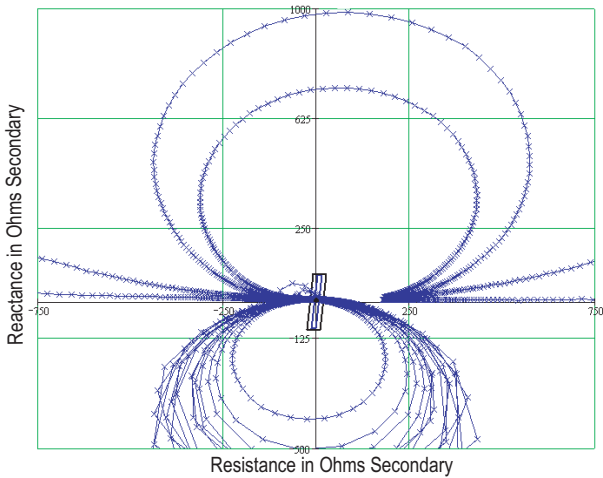

Fig. 16. Positive-Sequence Impedance Plane Plot of Unstable Swing Case

Fig. 17 is a zoomed-in version of Fig. 16 that shows the positive-sequence impedance entering the power swing and distance element characteristics.

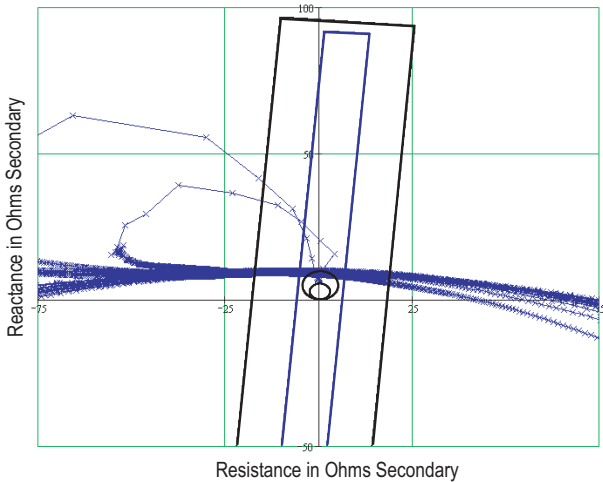

Fig. 17. Zoomed-In Positive-Sequence Impedance Plane Plot of Unstable Swing Case

Fig. 18 is a logic plot showing operation of the PSB element, the inner and outer blinder elements, and the phase distance elements.

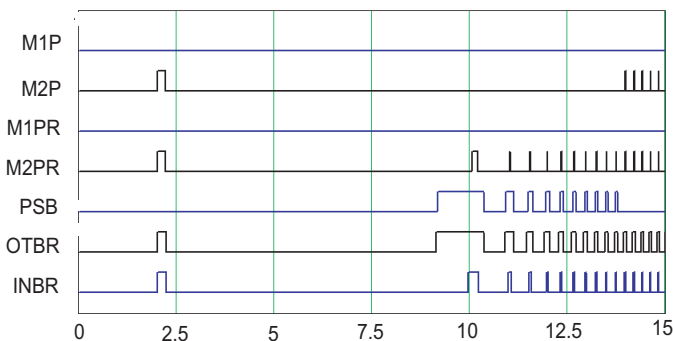

Fig. 18. Logic Output of Power Sing Blocking and Distance Elements

The logic output shows that the PSB scheme worked correctly for the first few slip cycles and correctly blocked the output of the Zone 2 element. However, the system continued to accelerate until the slip rate exceeded 5 Hz and the PSB element was no longer able to correctly operate.

VI. OTHER CONSIDERATIONS

This section describes some problem areas such as heavy load flow and challenges to setting power swing tripping elements.

A. Heavy Load Flow

References [7] [8] [9] [10] [11] recommend setting the power swing characteristic inside the maximum load condition but outside the maximum distance element reach. In long line applications with heavy load flow, following these settings guidelines may be difficult, if not impossible. Fortunately, most digital distance relays allow some form of programming capability to address these special cases. However, in order to set the relay correctly, stability studies are required; a simple impedance-based solution is not possible.

The approach for this application is to set the power swing blinder such that it is inside the maximum load flow impedance and the worst-case power swing impedance as shown in Fig. 19. Using this approach may result in “cutting-off” part of the distance element characteristic.

Special logic must be developed to allow operation of the distance element when the measured impedance is inside the power swing blinder and the associated distance element. For an internal three-phase fault, the implementation is relatively simple because the measured impedance will plot along the line characteristic. For phase-phase and phase-phase-earth faults, other supervision must be included, as the power swing element may not operate for these fault types. Typically, supervision by an unbalance fault detector, such as a negative-sequence directional element, is required. The logic is such that operation of both the directional element and the mho element (AND combination) allows an output from the distance element. A key point in this application is that the directional element must not operate for any worst-case swing condition, otherwise there is a risk of incorrect operation of the distance elements.

Fig. 19 shows the characteristic discussed in this section. Fig. 20 shows the logic implementation for this scheme.



Fig. 19. Impedance Plan Plot of High-Load Power Swing Blocking Scheme

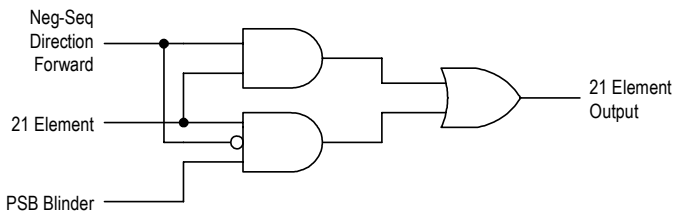

Fig. 20. High-Load Power Swing Blocking Logic

B. Power Swing Tripping

Power swing tripping schemes require much more study and analysis than PSB schemes. The goal of any power swing tripping scheme is to separate the power system at key locations to achieve a new steady-state operating condition. In many applications, the location where the power swing can be detected and the separation point are different. This means that extensive stability analysis must be done to locate the best detection and separation points. In addition, the timing of the scheme (or schemes) may be critical to ensure stable operations. Data obtained from a stability study are a key component in determining these factors.

Another consideration in setting power swing tripping schemes is the measured impedance for external faults. If the measured impedance falls within the power swing characteristic for a critical amount of time (the power swing tripping delay), the relay may incorrectly trip. Therefore, when applying impedance-based power swing elements, it is prudent practice to fully understand the measurement technique and how the element responds to external faults. Additional fault calculations may be required to determine if the element is secure. In addition, where a large reactance value is not a problem for PSB, the reactance reaches (top and bottom blinders) should be reduced for a power swing tripping scheme in order to reduce the exposure to external faults.

VII. CONCLUSIONS

1. PSB and tripping usually require some system analysis, such as stability studies, to properly apply and set the scheme.
2. In some applications, PSB elements may be set using an impedance-based method requiring development of system equivalents. Assumptions must be made about the worst-case power swing slip rate, unless historical or other data are available.
3. Power swing tripping must be set using data obtained from extensive stability studies. It is difficult to calculate all of the varying system conditions, create boundary equivalents, and then determine the best place to apply the scheme and separate the system.
4. Example cases show application of an impedance-based setting method using easily obtained system data and an assumed power swing slip rate. In both examples, this approach was shown to work well.

VIII. APPENDIX A

Fig. 21 shows the model used in Example 1. This system is developed from the two-area example power system in [12] with some slight modifications. The model was developed on a real-time digital simulator manufactured by RTDS Technologies. The model was developed by Ralph Folkers of Schweitzer Engineering Laboratories Inc., Pullman, WA.

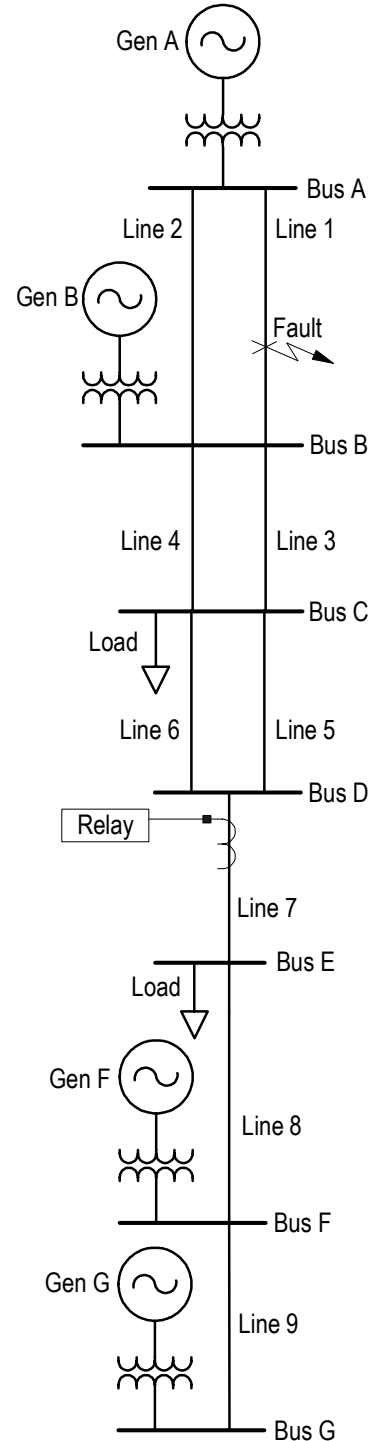

Fig. 21. Example System A

IX. APPENDIX B

Fig. 22 shows the model used in Example 2. This system was developed for relay performance testing for BC Hydro in British Columbia, Canada. The model was developed on a real-time digital simulator manufactured by RTDS Technologies. The model was developed by Venkat Mynam of Schweitzer Engineering Laboratories Inc., Pullman, WA. Allen Hiebert of BC Transmission Corporation provided the equivalent system data and validated the dynamic response of the reduced system model.

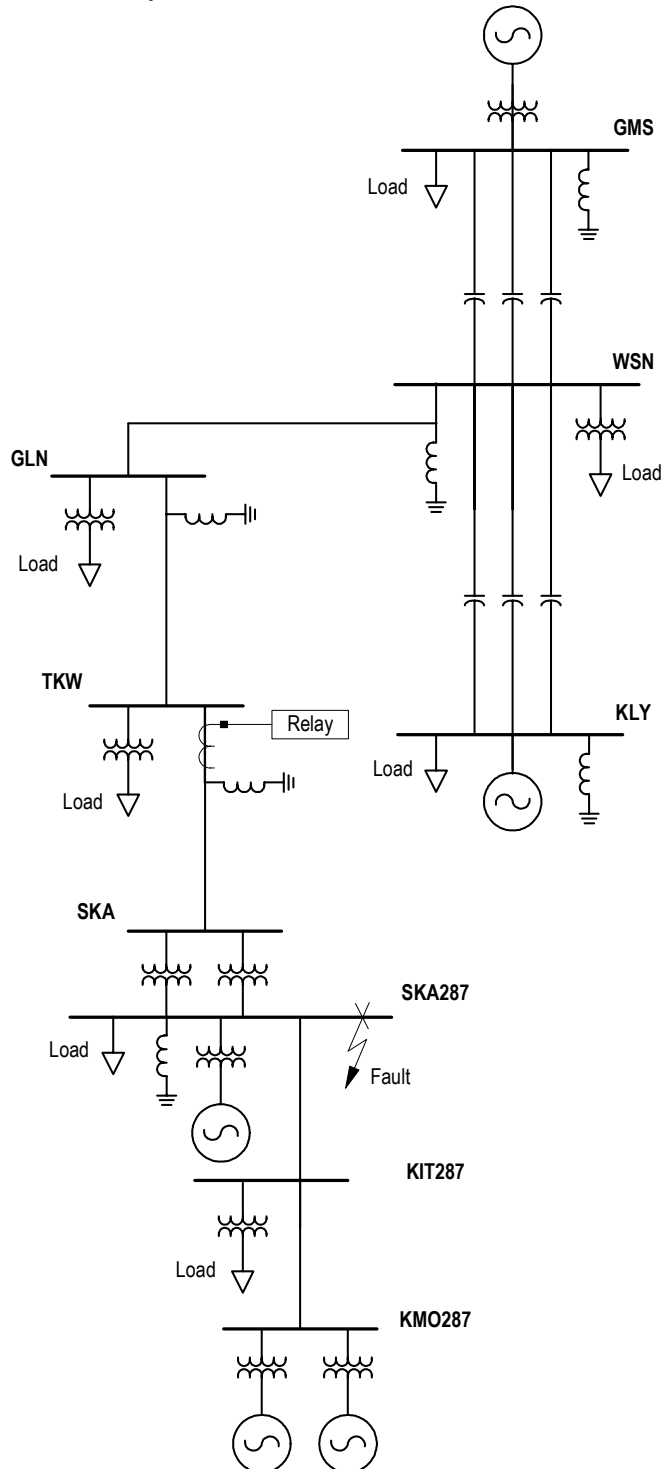

Fig. 22. Example System B

X. APPENDIX C

The MathCAD 2000 file, OSIMAG.MCD, calculates the inner and outer resistive blinder settings and the PSB delay given the system impedances and power swing slip rate. The file was written and formulated by Armando Guzman of Schweitzer Engineering Laboratories, Inc., Pullman, WA.

System Nominal frequency: $f = 60$ Hz

Maximum Slip frequency: $s = 4$ Hz

Distance Element Reach Setting in per unit of Z_{1L} : $Z_R = 1.3$

Transmission Line Impedance: $Z_{1L} = 3.19 \cdot e^{j \cdot \text{deg} \cdot 84.3} \Omega \text{ sec.}$

Equivalent Source S Impedance: $Z_{1S} = 3.11 \cdot e^{j \cdot \text{deg} \cdot 86.9} \Omega \text{ sec.}$

Equivalent Source R Impedance: $Z_{1R} = 1.97 \cdot e^{j \cdot \text{deg} \cdot 87.7} \Omega \text{ sec.}$

Total Transfer Impedance: $Z_T := Z_{1L} + Z_{1S} + Z_{1R}$

Determining Right Resistive Blinders Using Power Angle:

Inner Blinder Power Angle: $\delta_{INB} = 100$

Outer Blinder Power Angle: $\delta_{OTB} = 60$

Inner Right Resistive Blinder Setting:

$$INB := \frac{|Z_T|}{2 \cdot \tan \frac{\delta_{INB} \cdot \text{deg}}{2}} \quad INB = 3.469$$

Outer Right Resistive Blinder Setting:

$$OTB := \frac{|Z_T|}{2 \cdot \tan \frac{\delta_{OTB} \cdot \text{deg}}{2}} \quad INB = 7.16$$

Load angle increment between outer and inner blinders:

$$\Delta\delta_{IOB} := \delta_{INB} - \delta_{OTB}$$

Determining Power Angle Using Resistive Blinder Settings:

Inner Blinder Setting: $INBS = 3.5$

Outer Blinder Setting: $OTBS = 7.5$

Power Angle for Inner Resistive Blinder:

$$ANGI := 2 \cdot \text{atan} \frac{|Z_T|}{2 \cdot INBS} \cdot \frac{180}{\pi} \quad ANGI = 99.491$$

Power Angle for Outer Resistive Blinder:

$$ANGO := 2 \cdot \text{atan} \frac{|Z_T|}{2 \cdot OTBS} \cdot \frac{180}{\pi} \quad ANGO = 57.723$$

Load angle increment between outer and inner blinders:

$$\Delta\delta_{ANGIO} := ANGI - ANGO$$

**Determining Power Swing Blocking Delay (PSBD);
PSBD by Power angle set PSBDOP=1;
PSBD by blinder reach setting set PSBDOP=0.**

$$\text{PSBDOP} := 1$$

$$\text{PSBD} := \begin{cases} \frac{\Delta\delta\text{IOB} \cdot f}{s \cdot 360} & \text{if PSBDOP} \\ \frac{\Delta\delta\text{ANGIO} \cdot f}{s \cdot 360} & \text{otherwise} \end{cases}$$

Power Swing Blocking Delay Setting: PSBD = 1.667

CharacteristicPlots:

Mho characteristic:

$$Z1 := ZR \cdot ZIL \quad R1 := \text{Re}(Z1L) \quad X1 := \text{Im}(Z1L) \quad 1 := 0, 1..360 \quad \varepsilon_1 := 1$$

$$Z1_1 := \frac{Z1}{2} + \frac{Z1}{2} \cdot e^{j \cdot \varepsilon_1 \cdot \text{deg}}$$

Right side blinders:

$$\text{INB} := \begin{cases} \text{INB} & \text{if PSBDOP} \\ \text{INBS} & \text{otherwise} \end{cases} \quad \text{OTB} := \begin{cases} \text{OTB} & \text{if PSBDOP} \\ \text{OTBS} & \text{otherwise} \end{cases}$$

$$y := -75, -74..75$$

$$\text{INBR}_{y+75} := \frac{R1}{X1} \cdot y + \frac{|\text{INB}|}{\sin(\arg(Z1L))}$$

$$\text{OTBR}_{y+75} := \frac{R1}{X1} \cdot y + \frac{|\text{OTB}|}{\sin(\arg(Z1L))}$$

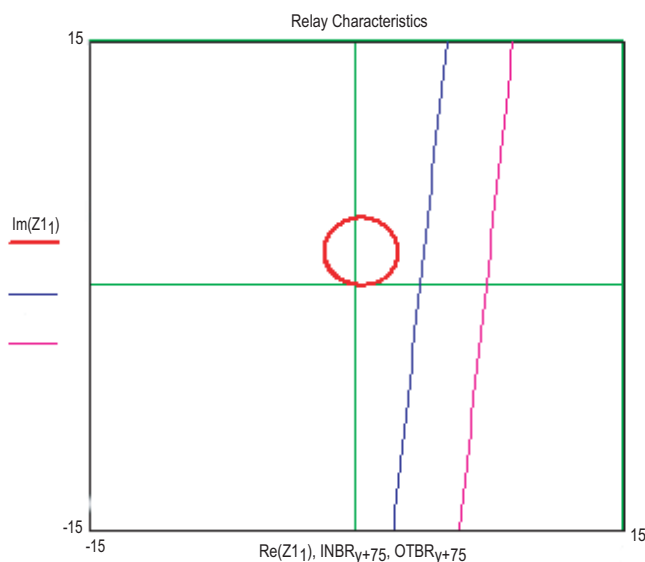

XI. REFERENCES

- [1] D. Tziouvaras and D. Hou, "Out-of-Step Protection Fundamentals and Advancements," *Proceedings of the 30th Annual Western Protective Relay Conference*, Spokane, WA, October 21–23, 2003.
- [2] G. Benmouyal, D. Tziouvaras, and D. Hou, "Zero-Setting Power-Swing Blocking Protection," *Proceedings of the 31st Annual Western Protective Relay Conference*, Spokane, WA, October 19–21, 2004.
- [3] J. Holbach, "New Out-of-Step Blocking Algorithm for Detecting Fast Power Swing Frequencies," *Proceedings of the 30th Annual Western Protective Relay Conference*, Spokane, WA, October 21–23, 2003.

- [4] C. W. Taylor, "A New Out-of-Step Relay With Rate of Change of Apparent Resistance Augmentation," *IEEE Transactions on Power Apparatus and Systems*, Vol. 102, No. 3, pp. 631–639, March 1983.
- [5] J. M. Haner, T. D. Laughlin, and C. W. Taylor, "Experience With the R-dot Out-of-Step Relay," *IEEE Transactions on Power Delivery*, Vol. 1, No. 3, pp. 35–39, April 1986.
- [6] E. O. Schweitzer III, G. Benmouyal, and A. Guzmán, "Synchronized Phasor Measurement in Protective Relays for Protection, Control, and Analysis of Electrical Power Systems," *Proceedings of the 29th Annual Western Protective Relay Conference*, Spokane, WA, October 22–24, 2002.
- [7] IEEE PSRC WG D6, "Power Swing and Out-of-Step Considerations on Transmission Line," Final draft, June 2005.
- [8] D. Hou, S. Chen, and S. Turner, "SEL-321-5 Relay Out-of-Step Logic," Schweitzer Engineering Laboratories, Inc. Application Guide AG97-13, July 23, 1997.
- [9] SEL-421 Relay Instruction Manual, January 2005.
- [10] ABB REL 531*2.5, Application Manual, Protect^{IT} Line High Speed Distance Protection Terminal, Document No. 1MRK 506 178-UEN, December 2003.
- [11] ABB REL 561*2.5, Application Manual, Protect^{IT} Line Differential And Distance Protection Terminal, Document No. 1MRK 506 184-UEN, December 2003.
- [12] Prabha Kundur, "Power System Stability," The EPRI Power System Engineering Series, McGraw Hill Inc., 1994.

XII. BIOGRAPHIES

Joe Mooney, P.E. received his B.S. in Electrical Engineering from Washington State University in 1985. He joined Pacific Gas and Electric Company upon graduation as a System Protection Engineer. In 1989, he left Pacific Gas and Electric and was employed by Bonneville Power Administration as a System Protection Maintenance District Supervisor. In 1991, he left Bonneville Power Administration and joined Schweitzer Engineering Laboratories, Inc. as an Application Engineer. Shortly after starting with SEL, he was promoted to Application Engineering Manager where he remained for nearly three years. He is currently the manager of the Power Engineering Group of the Research and Development department at Schweitzer Engineering Laboratories, Inc. He is a registered Professional Engineer in the State of California and Washington.

Normann Fischer joined Eskom as a Protection Technician in 1984. He received a Higher Diploma in Technology, with honors, from the Witwatersrand Technikon, Johannesburg, South Africa, in 1988, a B.Sc. in Electrical Engineering, with honors, from the University of Cape Town in 1993, and an M.S.E.E. from the University of Idaho in 2005. He was a Senior Design Engineer in Eskom's Protection Design Department for three years and then joined IST Energy as a Senior Design Engineer in 1996. In 1999, he joined Schweitzer Engineering Laboratories, Inc. as a Power Engineer in the Research and Development Division. He was a registered professional engineer in South Africa and a member of the South Africa Institute of Electrical Engineers.

Previously presented at the 2006 Texas A&M Conference for Protective Relay Engineers.

© 2006 IEEE – All rights reserved.
20050920 • TP6228-01